

outdoor recessed lights (in-ground/ in-wall/ceiling)

micro recessed lights



underwater recessed lights



buried up-lights

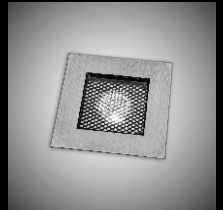

inground drive-over lights





Mounting:
buried in ground/wall/ceiling
Housing:
hard chrome-plated
stainless steel - 1.4401 (SUS316)
Diffuser:
tough tempered glass

LED: CREE/Edison
CRI: Ra>80
CCT:
CT40-4000K
CT50-5000K
CT60-6000K
RGB/RGBW/Amber
Note: * Other CRI/CCT
available on request

LED driver: external
LED driver options:
ND - non-dimmable
PH - phase dimmable
010V - 0-10V dimmable
DALI - compatible
Note: * Lm given in data
is based on 3000K

Application:
outdoors/indoors
floors/decks/pathways
landscapes
building facades
columns
Ambient Temp: -35°~+50°C

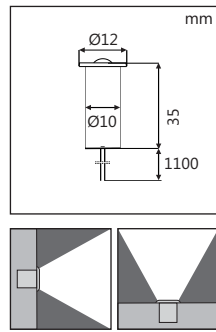

Ref Code 26.31.001.01.0.7
Watt 0.7W (WH, CREE)
Volt CC, 250mA
Lm(±) 50

Beam Angle: 80°

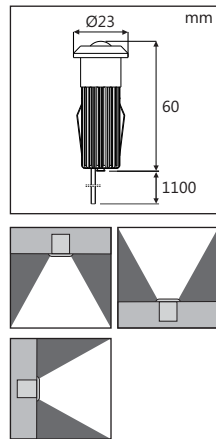

Ref Code 26.31.002.01.01
Watt 1W (WH, CREE)
Volt CC, 350mA
Lm(±) 90

Notes:
*fixed single colors available:
red, green, blue, amber

Beam Angle: 120°

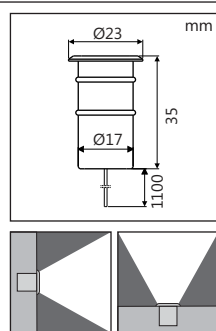

Ref Code 26.31.003.01.01
Watt 1W (WH, CREE)
Volt CC, 350mA
Lm(±) 90
26.31.003.02.0.5
Watt 0.5W (RGB, Edison)
Volt CV, 12V DC

Notes:
glass thickness is 3 mm

Beam Angle-Code:
20°-BA20
60°-BA60
RGB: 120°-BA120



Mounting:
buried in ground/wall/ceiling
Housing:
hard chrome-plated
stainless steel 1.4401 (SUS316)

LED: CREE/Epistar
CRI: Ra>80
CCT:
CT40-4000K
CT50-5000K
CT60-6000K
RGB/Amber
Note: * Other CRI/CCT
available on request

LED driver: external
LED driver options:
ND - non-dimmable

Note: * Lm given in data
is based on 3000K
Cable: 2*0.5m pvc connect
cable with male and female
connector

Application:
outdoors
floors/decks/pathways
landscapes
building facades
columns
Ambient Temp: -35°~+55°C

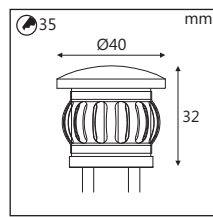
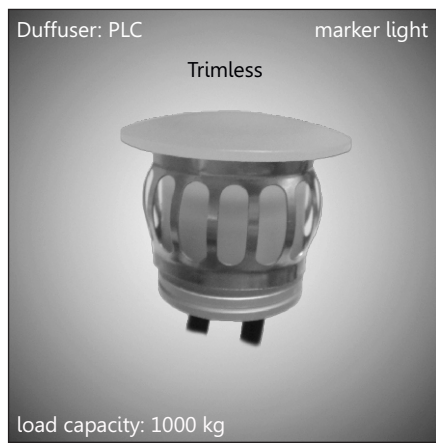

Ref Code	Watt	Lm(±)	Volt DC
26.25.004.01.0.5	0.5W	20	12V

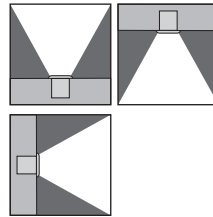

LED Color options:
CCT: 2700-6500K
fixed colors: red, green, blue, amber/RGB

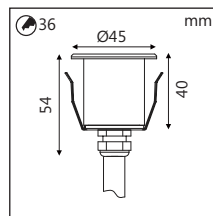

Ref Code	Watt	Lm(±)	Volt DC	Beam Angle-Code:
26.25.006.01.01	1W	80	12V	10°-BA10
26.25.006.02.03	3W(RGB)		12V	25°-BA25
				40°-BA40
				120°-BA120

LED Color options:
CCT: 2700-6500K
single colors: red, green, blue, yellow, amber
RGB (3-in-1) color changing

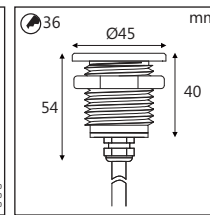
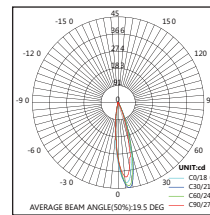
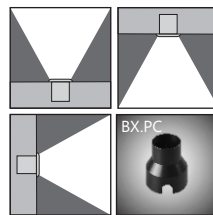

Mounting:
buried in ground/wall/ceiling
Housing:
hard chrome-plated
stainless steel - 1.4401 (SUS316)
Diffuser:
tempered glass

LED: CREE/Edison
CRI: Ra>80
CCT:
CT40-4000K
CT50-5000K
CT60-6000K
RGB/RGBW/Amber
Note: * Other CRI/CCT
available on request

LED driver: external
LED driver options:
ND - non-dimmable
PH - phase dimmable
010V - 0-10V dimmable
DALI - compatible
Note: * Lm given in data
is based on 3000K
Cable: waterproof design

Application:
outdoors
floors/decks/pathways
landscapes
building facades
columns
Ambient Temp: -35°~+55°C

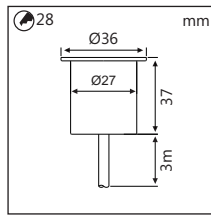

Ref Code	Watt	Volt	Lm(±)	N.W.,kg
26.31.007.01.01	1W (WH, CREE)	CV, 12/24V DC	30	0.25
26.31.007.02.01	1W (RGB, Edison)	CV, 24V DC		

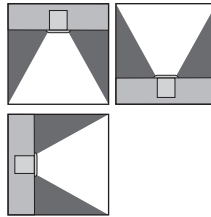

Note:
*glass thickness is 3 mm
*fixed single colors available:
red, green, blue, amber

Beam Angle: 120°

Housing options-Code:
brass-BRASS
stainless steel-SLS

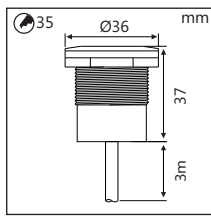

Ref Code	Watt	Volt	Lm(±)	N.W.,kg
26.31.008.01.01	1W (WH, CREE)	CV, 12/24V DC	50	0.3
26.31.008.02.01	1W (RGB, Edison)	CV, 12V DC		

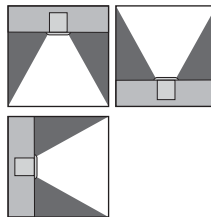

Note:
*glass thickness is 3 mm
*fixed single colors available:
red, green, blue, amber

Beam Angle: 120°

Housing options:
brass-BRASS
stainless steel-SLS

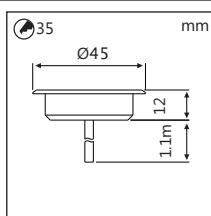

Ref Code	Watt	Volt	Lm(±)	N.W.,kg
26.31.009.01.01	1W (WH, CREE)	CC, 350mA	50	0.07
26.31.009.02.01	1W (Single, Edison)	CV, 12/24V DC		
	1W (RGB, Edison)	CV, 24V DC		

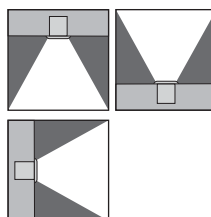

Note:
fixed single colors available:
red, green, blue, amber

Beam Angle: 120°

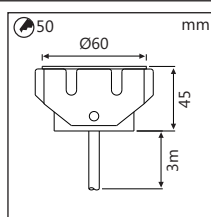

Ref Code	Watt	Volt	Lm(±)	N.W.,kg
26.31.010.01.01	1W (WH, CREE)	CC, 350mA	70	0.47
26.31.010.02.01	1W (WH, CREE)	CV, 12/24V DC	70	
26.31.010.03.03	3W (RGB, Edison)	CC, 350mA		

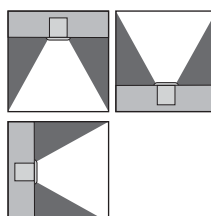

Note:
*glass thickness is 6 mm
*fixed single colors available:
red, green, blue, amber

Beam Angle-Code:
12°-BA12
45°-BA45





Mounting:
buried in ground/wall/ceiling
Housing:
- stainless steel 1.4401 (SUS316)
- die-cast aluminum
Diffuser:
tough tempered glass

LED: CREE/Epistar
CRI: Ra>80
LED Color options:
CCT: 2700-6500K
red-RD/ green-GR/ blue-BL
yellow-YL/ amber-AMB
RGB (3-in-1) color changing
Note: * Other CRI/CCT available on request

LED driver: external
LED driver options:
ND - non-dimmable
PH - phase dimmable
010V - 0-10V dimmable
DALI - compatible
Note: * Lm given in data is based on 3000K
Cable: standard length is 0.5m (4m is on request)

Application:
outdoors
floors/decks/pathways
landscapes
building facades
columns
Ambient Temp: -35°~+55°C

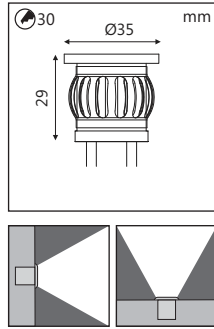

Ref Code	Watt	Lm(±)	Volt
26.25.011.01.0.5	0.5W	20	12V DC
26.25.011.02.0.5	0.5W(RGB)	-	12V DC

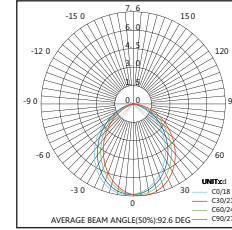

Beam Angle: 120°

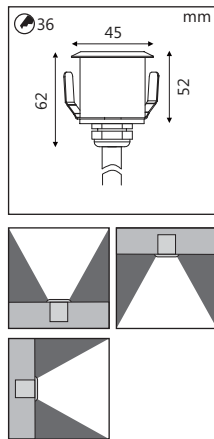

Ref Code	Watt	Lm(±)	Volt
26.25.012.01.1.5	1.5W	77	12V DC
26.25.012.02.1.5	1.5W(RGB)	-	12V DC

Beam Angle-Code:
15°-BA15
25°-BA25
40°-BA40
60°-BA60

Note:
* fully stainless housing and trim is available on request. **Code:** HS.SLS



Mounting:
buried in ground/wall/ceiling

Housing:
die-cast powder coated aluminum

Trim:
stainless steel - 1.4401 (SUS316)

Diffuser:
frosted step tempered glass

Gasket:
molding shaped silicon seal

LED: Osram

CRI: Ra>80

CCT:
CT40-4000K
CT50-5000K
CT60-6000K
RGB/RGBW/Amber

Note: * Other CRI/CCT available on request

LED driver: external

Volt AC: 240V

Volt DC: 24V

Frequency: 50/60Hz

Power Cable:
(DC 24V) 2x1.0mm²/L=2.0m
(AC 220V) 3x1.0mm²/L=2.0m
(RGB) 4x0.75mm²/L=0.5m

Application:
outdoors
floors/decks/pathways
landscapes
building facades
columns

Ambient Temp: -35°~+55°C

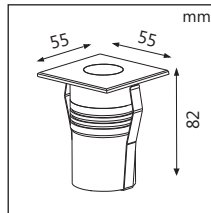
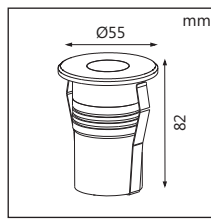

Ref Code	Watt	Volt	mA	Lm (±)
26.27.015.01.01	1W	240V AC	10	20
26.27.015.02.1.3	1.3W	24V DC	54	25

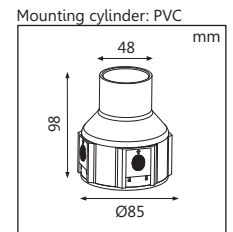
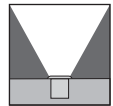

Beam Angle: 120°

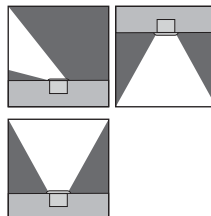
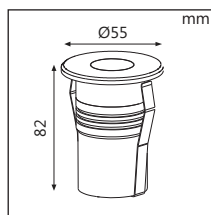

Ref Code	Watt	Volt	mA	Lm (±)
26.27.016.01.02	2W	24V DC	105	110
26.27.016.02.02	2W	240V AC	28	
26.27.016.03.02	2W(RGB 3-in-1)	24V DC(R/G/B)	38/53/54	

Beam Angle-Code:

SYM **ASM**
 9°-BA9 35°-BA35
 15°-BA15 45°-BA45
 20°-BA20 **RGB**
 30°-BA30 30°-BA30
 35°-BA35
 45°-BA45

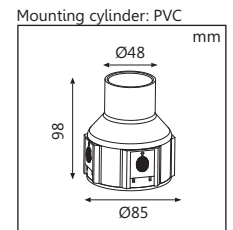

Lens-Code:
symmetric-SYM
asymmetric-ASM

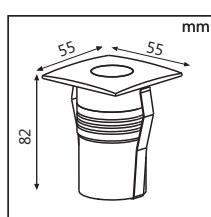
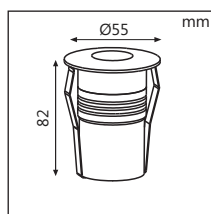
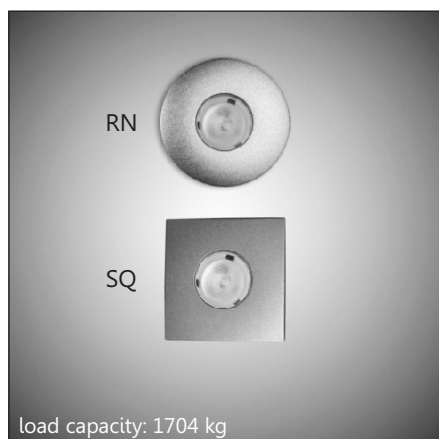

Ref Code	Watt	Volt	mA	Lm (±)
26.27.017.01.02	2W	24V DC	110	110
26.27.017.02.02	2W	240V AC	30	110
26.27.017.03.02	2W(RGB 3-in-1)	24V DC(R/G/B)	40/60/60	89

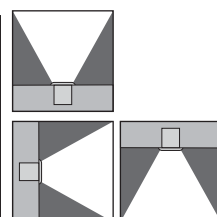

Beam Angle-Code:

SYM
 25°-BA25
RGB
 30°-BA30
ASM
 35°-BA35
 45°-BA45

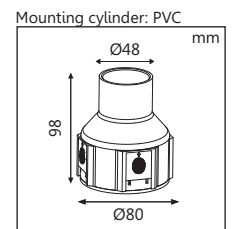

Lens-Code:
symmetric-SYM
asymmetric-ASM

Mounting:
buried in ground/wall
Housing:
fully stainless steel 1.4401 (SUS316)
optionally: brass (HS.BRASS)
Diffuser: opal/clear tempered glass
Fixing springs:
stainless steel 1.4401 (SUS316)
Optionally:
PC installation cylinder (BX.PC)

LED: CREE/EDISON
CRI: Ra>80
CCT:
CT27-2700K
CT30-3000K
CT40-4000K
CT60-6000K
Note: * Other CRI/CCT
available on request

LED driver: external
Volt AC: 220-240V
Frequency: 50-60Hz
options:
ND - non-dimmable
PH - phase dimmable
010V - 0-10V dimmable
DALI - compatible

Application:
outdoor
water landscapes
swimming pools/ponds
fountain/aquariums
recreational facilities
Ambient Temp: -20°~+40°C

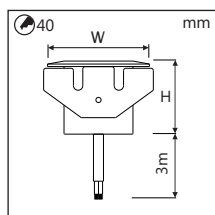

Ref Code	Watt	Volt	WxHxC.O.
37.31.001.01.01	1W (WH, CREE)	CC, 350mA	SQ: (45x45)x40x32
37.31.002.01.01	1W (WH, CREE)	CV, 12/24V DC	RN: 40x40x31

Lumen output: 90 lm/W

Note:
*glass thickness is 3 mm
*fixed single colors available:
red, green, blue, amber

Beam Angle-Code:
20°-BA20
60°-BA60

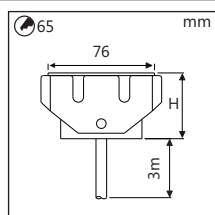

Ref Code	Watt	Volt	Lm(±)	H
37.31.003.01.03	3W (WH, CREE)	CC, 350mA	270	47
37.31.003.02.03	3W (WH, CREE)	CV, 12/24V DC	270	47
37.31.003.03.03	3W (RGB, Edison)	CC, 350mA	47	47
37.31.003.04.06	6W (WH, CREE)	CC, 500mA	500	47
37.31.004.02.09	9W (RGB, Edison)	CC, 350mA	86	86

9W (3x3W) fixed single color Lm:
red: 190lm
green: 325lm
blue: 110lm

Notes:
1. fixed single colors available:
red, green, blue, amber
2. brass housing is optional:
code: **HS.BRASS**

Beam Angle-Code:
20°-BA20
60°-BA60
RGB: 45°-BA45

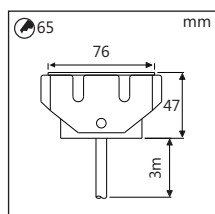

Ref Code	Watt	Volt	Lm(±)
37.31.005.01.03	3W (WH, CREE)	CC, 350mA	270
37.31.005.02.03	3W (WH, CREE)	CV, 12/24V DC	270
37.31.005.03.07	7W (RGB, Lamina)	CC, 350mA	

Beam Angle: 120°





Mounting:
buried in ground/wall/ceiling
Housing:
die-cast aluminum
Trim: hard chrome-plated
stainless steel 1.4401 (SUS316)
Diffuser:
step tempered glass
Gasket:
molding shaped silicon seal

LED: COB
(Osram/Bridgelux)
CRI: Ra>80
CCT:
CT40-4000K
CT50-5000K
CT60-6000K
RGB/RGBW/Amber
Note: * Other CRI/CCT
available on request

LED driver: external
constant current
Volt AC: 240V
Volt DC: 24V
Frequency: 50/60Hz
Power Cable:
(DC 24V) 2x1.0mm²/L=2.0m
(AC 220V) 3x1.0mm²/L=2.0m
(RGB) 4x0.75mm²/L=0.5m

Application:
outdoors
floors/decks/pathways
landscapes
building facades
columns
Ambient Temp: -35°~+55°C

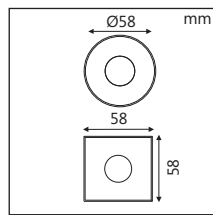
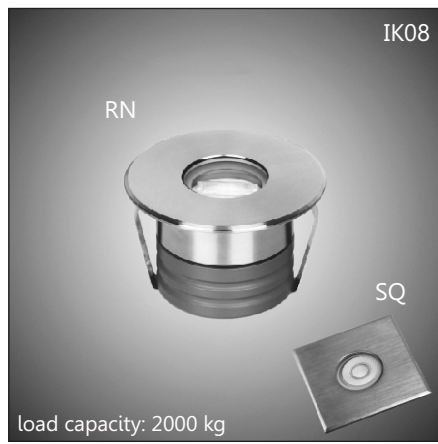

Ref Code	Watt	Volt	mA	Lm(±)
24.27.007.01.02	2W	24V DC	88	120
24.27.007.02.02	2W	240V AC	29	

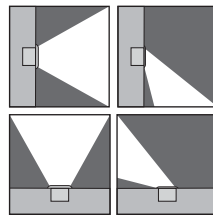

Beam Angle-Code:
SYM **ASM**
9°-BA09 35°-BA35
15°-BA15 45°-BA45
20°-BA20
30°-BA30
45°-BA45

Lens-Code:
symmetric-SYM
asymmetric-ASM

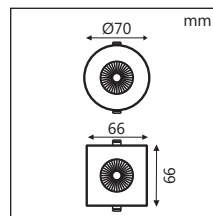
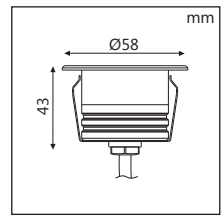

Ref Code	Watt	Volt	mA	Lm(±)
24.27.008.01.05	5W	24V DC	265	400
24.27.008.02.05	5W	240V AC	32	

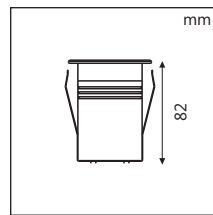

Beam Angle-Code:
18°-BA18
24°-BA24
32°-BA32

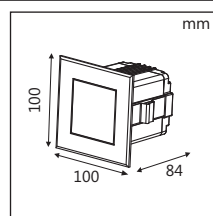
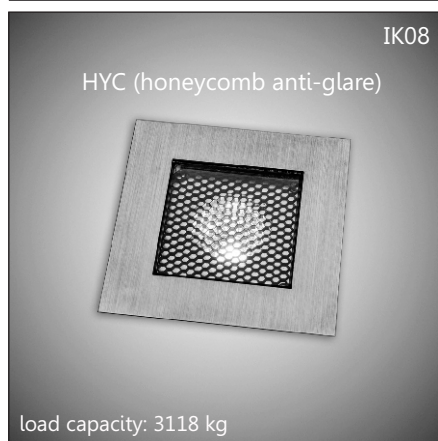
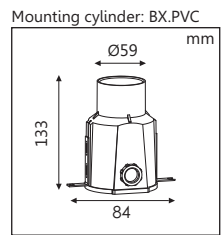

Ref Code	Watt	Volt	mA	Lm(±)
24.27.009.01.06	6W	24V DC	72	700
24.27.009.02.06	6W	240V AC	40	



Beam Angle-Code:
18°-BA18
25°-BA25
40°-BA40

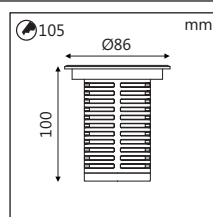
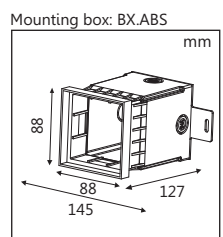
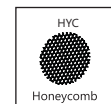

Ref Code	Watt	Volt	Lm(±)
24.25.052.01.07	7W	24V DC	360
24.25.052.02.07	7W	240V AC	420

LED white CCT range:
2700-6500K

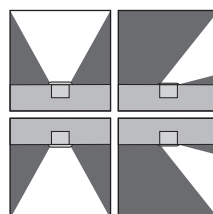

Beam Angle-Code:
15°-BA15
25°-BA25
40°-BA40

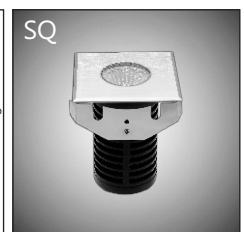
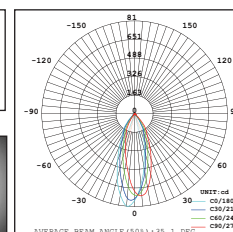
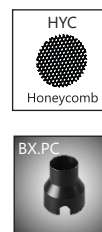

buried up-lights

Mounting: buried in ground
Housing: die-cast powder coated aluminum
Trim: hard chrome-plated stainless steel 1.4401 (SUS316)
Diffuser: step tempered glass
Gasket: molding shaped silicone seal
Note:
 * Other CRI/CCT available on request

LED: Cree
CRI: Ra > 70
CCT: CT30-3000K
 CT60-6000K
Note: * Lm given in data is based on 4000K

LED driver: Constant Voltage Input
 Constant Current Output
Volt AC: 240V
Volt DC: 24V
Frequency: 50/60Hz
LED driver options:
 ND - non-dimmable
 PH - phase dimmable
 010V - 0-10V dimmable
 DALI - compatible

Application:
 outdoors
 floors/decks/pathways
 landscapes
 building facades
 columns
Ambient Temp: -35°~+55°C

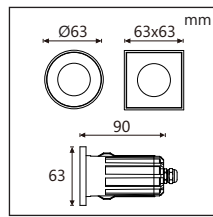

Ref Code	Watt	Volt	mA	Lm(±)
24.27.062.01.6.3	6.3W (COB)	24V DC	265	550
24.27.062.02.6.7	6.7W (COB)	240V AC	32	

Beam Angle-Code:
 18°-BA18
 24°-BA24
 32°-BA32

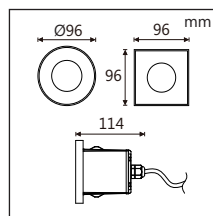
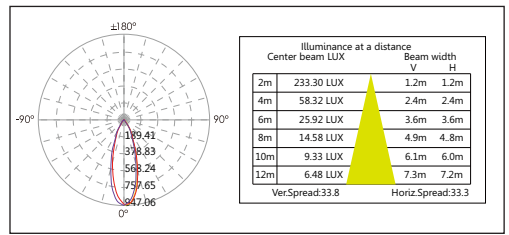
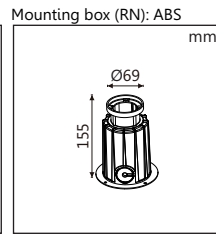
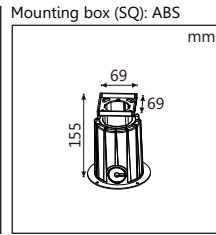
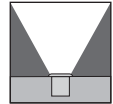

Ref Code	Watt	Volt	mA	Lm(±)
24.27.063.01.7.5	7.5W (COB)	24V DC	320	900
24.27.063.02.8.5	8.5W (COB)	240V AC	40	

Beam Angle-Code:
 15°-BA15
 24°-BA24
 38°-BA38
 60°-BA60

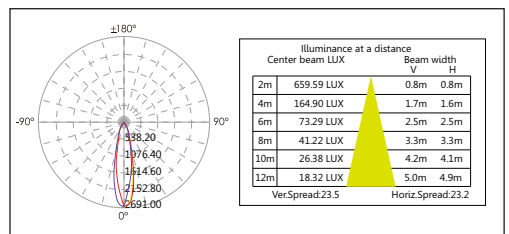
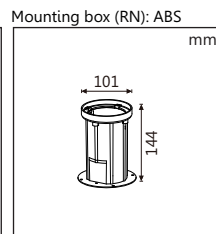
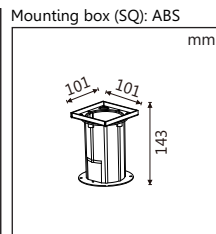
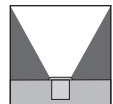

Mounting: buried in ground

Housing:

die-cast powder coated aluminum

Trim: hard chrome-plated stainless steel 1.4401 (SUS316)

Diffuser: step tempered glass

Gasket: molding shaped silicone seal

Note:

* Other CRI/CCT available on request

LED: Cree

CRI: Ra > 70

CCT:

RGB

LED driver:

Constant Voltage Input

Constant Current Output

Volt AC: 240V

Volt DC: 24V

Frequency: 50/60Hz

LED driver options:

ND - non-dimmable

PH - phase dimmable

010V - 0-10V dimmable

DALI - compatible

Application:

outdoors

floors/decks/pathways

landscapes

building facades

columns

Ambient Temp: -35° ~ +55°C

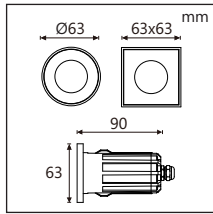

Ref Code	Watt	Volt	mA	Lm(±)
24.27.064.01.1.3	1.3W	24V DC	54	7
24.27.064.02.01	1W	240V AC	10	7
24.27.064.03.1.5	1.5W (RGB)	24V DC	21	3.3

Beam Angle: 120°

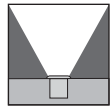

Mounting box (SQ): ABS

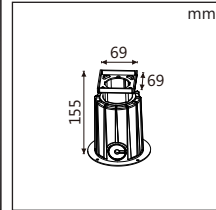

Mounting box (RN): ABS

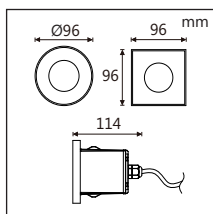
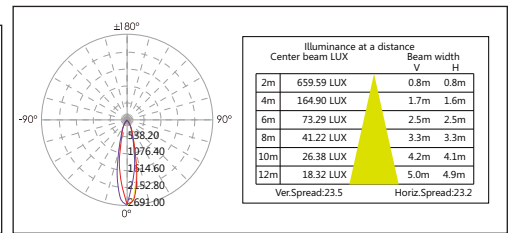
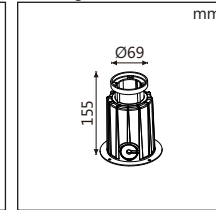

Ref Code	Watt	Volt	mA	Lm(±)
24.27.065.01.1.2	1.2W	24V DC	51	13
24.27.065.02.1.8	1.8W	240V AC	30	12
24.27.065.03.1.2	1.2W (RGB)	24V DC	17	6

Beam Angle: 120°

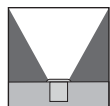

Mounting box (SQ): ABS

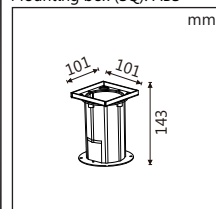

Mounting box (RN): ABS

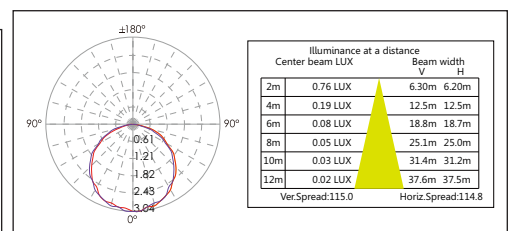
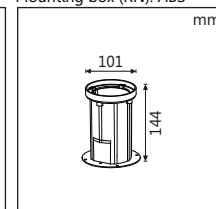

Mounting:
buried in ground
Housing:
die-cast aluminum
Trim:
die-cast aluminum
Diffuser: glass
Fitting's finish options:
11-black matte
01-white matte

LED: Cree
CRI: Ra>80 (±3000K)
CCT:
CT30-3000K
CT40-4000K
Note: * Lm given in data is based on 3000K

LED driver options:
integral/remote
Volt DC: 24V
Volt AC: 220-240V
Frequency: 50-60Hz
LED driver options:
ND - non-dimmable
PH - phase dimmable
010V - 0-10V dimmable
DALI - compatible

Application:
outdoors
floors/decks/pathways
landscapes
building facades
columns
Ambient Temp: -35°~+55°C

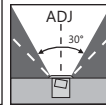
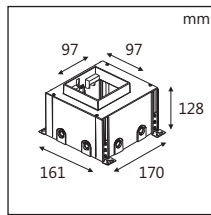
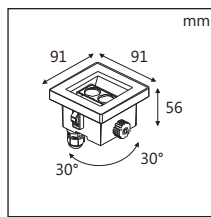
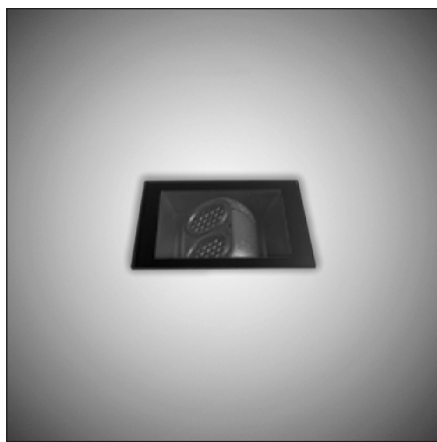

Ref Code	Watt	Volt	mA	Lm(±)
24.08.088.01.04	2x2.1W	24V DC	700	430
24.08.088.02.04	2x2.1W	240V AC	700	430

Beam Angle-Code:

- 6°-BA06
- 13°-BA13
- 20°-BA20
- 30°-BA30
- 40°-BA40
- 10°x35°-BA10x35
- 20°x40°-BA20x40

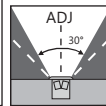
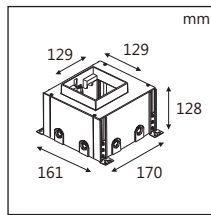
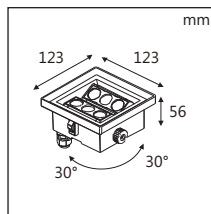
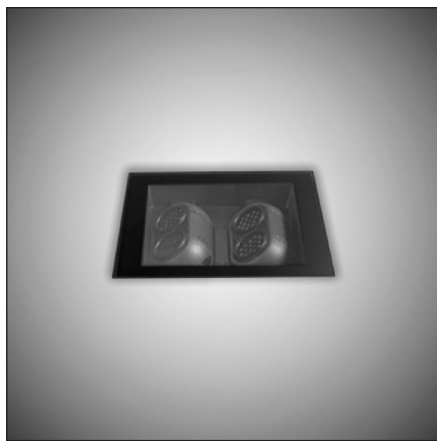

Ref Code	Watt	Volt	mA	Lm(±)
24.08.089.01.08	4x2.1W	24V DC	700	2x430
24.08.089.02.08	4x2.1W	240V AC	700	2x430

Beam Angle-Code:

- 6°-BA06
- 13°-BA13
- 20°-BA20
- 30°-BA30
- 40°-BA40
- 10°x35°-BA10x35
- 20°x40°-BA20x40

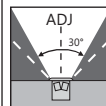
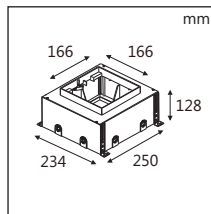
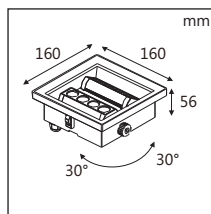
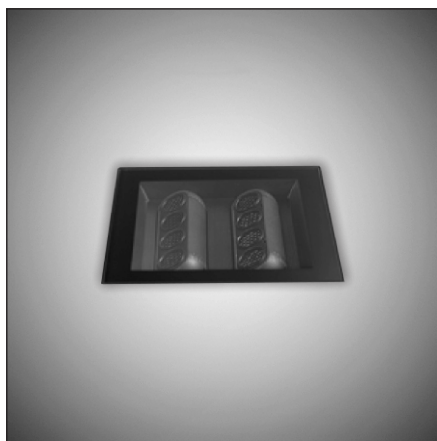

Ref Code	Watt	Volt	mA	Lm(±)
24.08.090.01.13	8x1.5W	24V DC	500	2x650
24.08.090.02.13	8x1.5W	240V AC	500	2x650

Beam Angle-Code:

- 6°-BA06
- 13°-BA13
- 20°-BA20
- 30°-BA30
- 40°-BA40
- 10°x35°-BA10x35
- 20°x40°-BA20x40

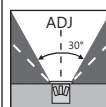
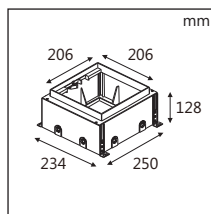
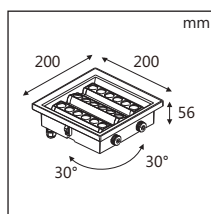
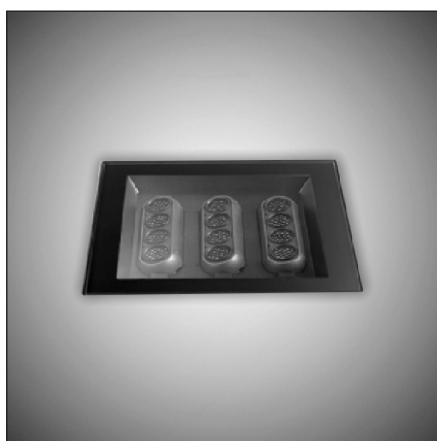

Ref Code	Watt	Volt	mA	Lm(±)
24.08.091.01.18	12x1.5W	24V DC	500	3x650
24.08.091.02.18	12x1.5W	240V AC	500	3x650

Beam Angle-Code:

- 6°-BA06
- 13°-BA13
- 20°-BA20
- 30°-BA30
- 40°-BA40
- 10°x35°-BA10x35
- 20°x40°-BA20x40

Mounting:
buried in ground
Housing:
die-cast aluminum
Trim:
die-cast aluminum
Diffuser: glass
Fitting's finish options:
11-black matte
01-white matte

LED: Cree
CRI: Ra>80 (±3000K)
CCT:
CT30-3000K
CT40-4000K
Note: * Lm given in data is based on 3000K

LED driver options:
integral/remote
Volt DC: 24V
Volt AC: 220-240V
Frequency: 50-60Hz
LED driver options:
ND - non-dimmable
PH - phase dimmable
010V - 0-10V dimmable
DALI - compatible

Application:
outdoors
floors/decks/pathways
landscapes
building facades
columns
Ambient Temp: -35°~+55°C



		Ref Code 24.08.096.01.04 24.08.096.02.04	Watt 2x2.1W 2x2.1W	Volt 24V DC 240V AC	mA 700 700	Lm(±) 430 430

Beam Angle-Code:
6°-BA06
13°-BA13
20°-BA20
30°-BA30
40°-BA40
10°x35°-BA10x35
20°x40°-BA20x40

		Ref Code 24.08.097.01.08 24.08.097.02.08	Watt 4x2.1W 4x2.1W	Volt 24V DC 240V AC	mA 700 700	Lm(±) 2x430 2x430

Beam Angle-Code:
6°-BA06
13°-BA13
20°-BA20
30°-BA30
40°-BA40
10°x35°-BA10x35
20°x40°-BA20x40

		Ref Code 24.08.098.01.13 24.08.098.02.13	Watt 8x1.5W 8x1.5W	Volt 24V DC 240V AC	mA 500 500	Lm(±) 2x650 2x650

Beam Angle-Code:
6°-BA06
13°-BA13
20°-BA20
30°-BA30
40°-BA40
10°x35°-BA10x35
20°x40°-BA20x40

		Ref Code 24.08.099.01.18 24.08.099.02.18	Watt 12x1.5W 12x1.5W	Volt 24V DC 240V AC	mA 500 500	Lm(±) 3x650 3x650

Beam Angle-Code:
6°-BA06
13°-BA13
20°-BA20
30°-BA30
40°-BA40
10°x35°-BA10x35
20°x40°-BA20x40



Mounting:
buried in ground
Housing:
die-cast aluminum
Trim:
hard chrome-plated
stainless steel 1.4401 (SUS316)
Diffuser: glass

LED: Cree
CRI: Ra>80 (±3000K)
CCT:
CT30-3000K
CT40-4000K
Note: * Lm given in
data is based on 3000K

LED driver options:
integral/remote
Volt DC: 24V
Volt AC: 220-240V
Frequency: 50-60Hz
LED driver options:
ND - non-dimmable
PH - phase dimmable
010V - 0-10V dimmable
DALI - compatible

Application:
outdoors
floors/decks/pathways
landscapes
building facades
columns
Ambient Temp: -35°~+55°C



		Ref Code 24.08.084.01.04	Watt 2x2.1W	Volt 24V DC	mA 700	Lm(±) 430
		24.08.084.02.04	2x2.1W	240V AC	700	430
		Beam Angle-Code:				
		6°-BA06 13°-BA13 20°-BA20 30°-BA30 40°-BA40 10°x35°-BA10x35 20°x40°-BA20x40				

		Ref Code 24.08.085.01.08	Watt 4x2.1W	Volt 24V DC	mA 700	Lm(±) 2x430
		24.08.085.02.08	4x2.1W	240V AC	700	2x430
		Beam Angle-Code:				
		6°-BA06 13°-BA13 20°-BA20 30°-BA30 40°-BA40 10°x35°-BA10x35 20°x40°-BA20x40				

		Ref Code 24.08.086.01.12	Watt 8x1.5W	Volt 24V DC	mA 500	Lm(±) 2x650
		24.08.086.02.12	8x1.5W	240V AC	500	2x650
		Beam Angle-Code:				
		6°-BA06 13°-BA13 20°-BA20 30°-BA30 40°-BA40 10°x35°-BA10x35 20°x40°-BA20x40				

		Ref Code 24.08.087.01.18	Watt 12x1.5W	Volt 24V DC	mA 500	Lm(±) 3x650
		24.08.087.02.18	12x1.5W	240V AC	500	3x650
		Beam Angle-Code:				
		6°-BA06 13°-BA13 20°-BA20 30°-BA30 40°-BA40 10°x35°-BA10x35 20°x40°-BA20x40				

buried up-lights

Mounting:
buried in ground
Housing:
die-cast aluminum
Trim:
hard chrome-plated
stainless steel 1.4401 (SUS316)
Diffuser: glass

LED: Cree
CRI: Ra>80 (±3000K)
CCT:
CT30-3000K
CT40-4000K
Note: * Lm given in
data is based on 3000K

LED driver options:
integral/remote
Volt DC: 24V
Volt AC: 220-240V
Frequency: 50-60Hz
LED driver options:
ND - non-dimmable
PH - phase dimmable
010V - 0-10V dimmable
DALI - compatible

Application:
outdoors
floors/decks/pathways
landscapes
building facades
columns
Ambient Temp: -35°~+55°C

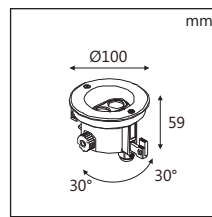

Ref Code	Watt	Volt	mA	Lm(±)
24.08.092.01.04	2x2.1W	24V DC	700	430
24.08.092.02.04	2x2.1W	240V AC	700	430

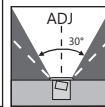
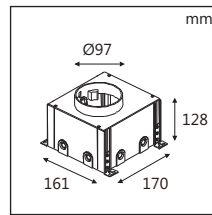

Beam Angle-Code:

- 6°-BA06
- 13°-BA13
- 20°-BA20
- 30°-BA30
- 40°-BA40
- 10°x35°-BA10x35
- 20°x40°-BA20x40

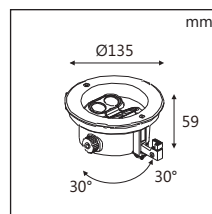

Ref Code	Watt	Volt	mA	Lm(±)
24.08.093.01.08	4x2.1W	24V DC	700	2x430
24.08.093.02.08	4x2.1W	240V AC	700	2x430

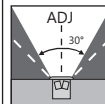
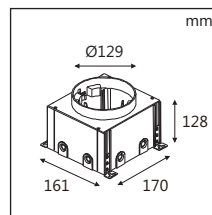

Beam Angle-Code:

- 6°-BA06
- 13°-BA13
- 20°-BA20
- 30°-BA30
- 40°-BA40
- 10°x35°-BA10x35
- 20°x40°-BA20x40

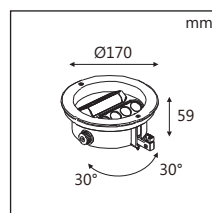
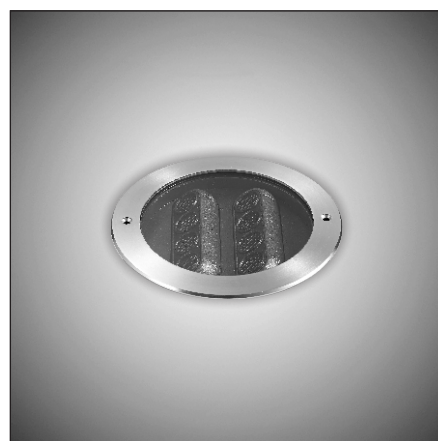

Ref Code	Watt	Volt	mA	Lm(±)
24.08.094.01.13	8x1.5W	24V DC	500	2x650
24.08.094.02.13	8x1.5W	240V AC	500	2x650

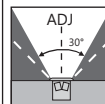
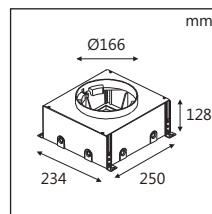

Beam Angle-Code:

- 6°-BA06
- 13°-BA13
- 20°-BA20
- 30°-BA30
- 40°-BA40
- 10°x35°-BA10x35
- 20°x40°-BA20x40

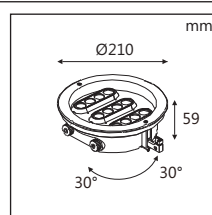
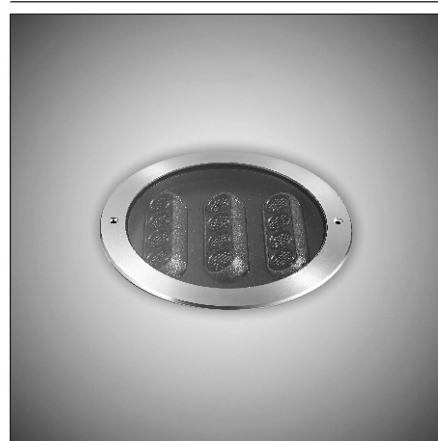

Ref Code	Watt	Volt	mA	Lm(±)
24.08.095.01.18	12x1.5W	24V DC	500	3x650
24.08.095.02.18	12x1.5W	240V AC	500	3x650

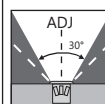
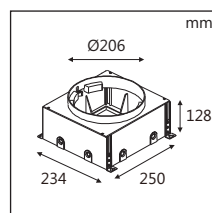

Beam Angle-Code:

- 6°-BA06
- 13°-BA13
- 20°-BA20
- 30°-BA30
- 40°-BA40
- 10°x35°-BA10x35
- 20°x40°-BA20x40

Mounting:
buried in ground
Housing:
die-cast aluminum
Trim:
die-cast aluminum
Diffuser: tempered opal glass

LED: Cree
CRI: Ra>80 (±3000K)
CCT:
CT30-3000K
CT40-4000K
Note: * Lm given in data is based on 3000K

LED driver options:
integral/remote
Volt DC: 24V
Volt AC: 220-240V
Frequency: 50-60Hz
LED driver options:
ND - non-dimmable
PH - phase dimmable
010V - 0-10V dimmable
DALI - compatible

Application:
outdoors
public/private/residential
canopies, porches, etc.
Ambient Temp: -50°~+60°C

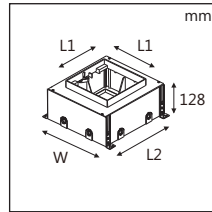
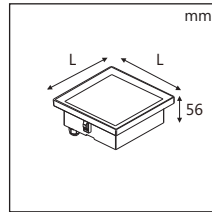

Ref Code	Watt	Volt	mA	Lm(±)	LxL
24.08.108.01.05	12x0.4W	24V DC	350	528	91
24.08.108.02.06	12x0.5W	240V AC	350	737	91
24.08.109.01.10	24x0.4W	24V DC	350	1056	123
24.08.109.02.13	24x0.5W	240V AC	350	1474	123
24.08.110.01.14	36x0.4W	24V DC	500	1584	160
24.08.110.02.18	36x0.5W	240V AC	500	2106	160
24.08.111.01.19	48x0.4W	24V DC	700	2112	200
24.08.111.02.25	48x0.5W	240V AC	700	2948	200

Mounting box
L1xL2xW:
97x170x161
129x170x161
166x250x234
206x250x234

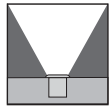

Beam Angle: 120°

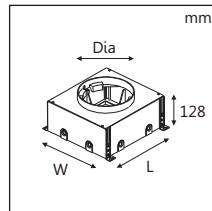
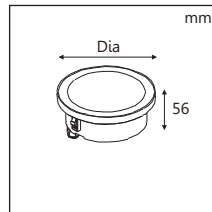

Ref Code	Watt	Volt	mA	Lm(±)	Dia
24.08.112.01.05	12x0.4W	24V DC	350	528	92
24.08.112.02.06	12x0.5W	240V AC	350	737	92
24.08.113.01.10	24x0.4W	24V DC	350	1056	125
24.08.113.02.13	24x0.5W	240V AC	350	1474	125
24.08.114.01.14	36x0.4W	24V DC	500	1584	160
24.08.114.02.18	36x0.5W	240V AC	500	2106	160
24.08.115.01.19	48x0.4W	24V DC	700	2112	200
24.08.115.02.25	48x0.5W	240V AC	700	2948	200

Mounting box
DiaxLxW:
97x170x161
129x170x161
166x250x234
206x250x234

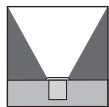

Beam Angle: 120°

buried up-lights

Mounting:
buried in ground
Housing:
die-cast aluminum
Trim:
hard chrome-plated
stainless steel 1.4401 (SUS316)
Diffuser: tempered opal glass

LED: Cree
CRI: Ra>80 (±3000K)
CCT:
CT30-3000K
CT40-4000K
Note: * Lm given in
data is based on 3000K

LED driver options:
integral/remote
Volt DC: 24V
Volt AC: 220-240V
Frequency: 50-60Hz
LED driver options:
ND - non-dimmable
PH - phase dimmable
010V - 0-10V dimmable
DALI - compatible

Application:
outdoors
public/private/residential
canopies, porches, etc.
Ambient Temp: -50°~+60°C

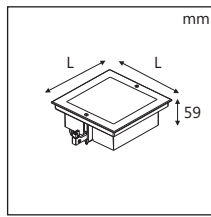

Ref Code	Watt	Volt	mA	Lm(±)	LxL
24.08.100.01.05	12x0.4W	24V DC	350	528	100
24.08.100.02.06	12x0.5W	240V AC	350	737	100
24.08.101.01.10	24x0.4W	24V DC	350	1056	135
24.08.101.02.13	24x0.5W	240V AC	350	1474	135
24.08.102.01.14	36x0.4W	24V DC	500	1584	170
24.08.102.02.18	36x0.5W	240V AC	500	2106	170
24.08.103.01.19	48x0.4W	24V DC	700	2112	210
24.08.103.02.25	48x0.5W	240V AC	700	2948	210

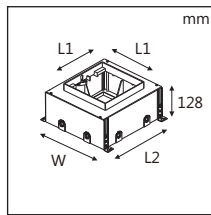

Mounting box
L1xL2xW:
97x170x161
129x170x161
166x250x234
206x250x234

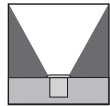

Beam Angle: 120°

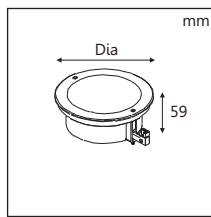

Ref Code	Watt	Volt	mA	Lm(±)	Dia
24.08.104.01.05	12x0.4W	24V DC	350	528	100
24.08.104.02.06	12x0.5W	240V AC	350	737	100
24.08.105.01.10	24x0.4W	24V DC	350	1056	135
24.08.105.02.13	24x0.5W	240V AC	350	1474	135
24.08.106.01.14	36x0.4W	24V DC	500	1584	170
24.08.106.02.18	36x0.5W	240V AC	500	2106	170
24.08.107.01.19	48x0.4W	24V DC	700	2112	210
24.08.107.02.25	48x0.5W	240V AC	700	2948	210

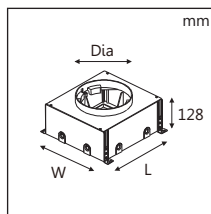

Mounting box
DiaxLxW:
97x170x161
129x170x161
166x250x234
206x250x234

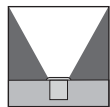

Beam Angle: 120°

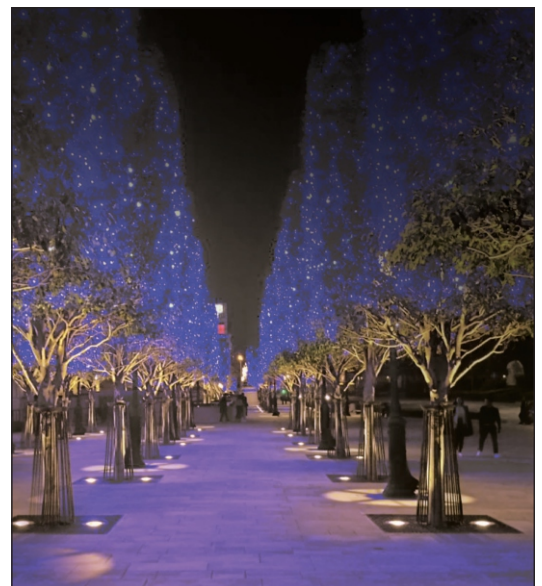

Mounting: buried in ground

Housing:

die-cast powder coated aluminum

Trim: hard chrome-plated stainless steel 1.4401 (SUS316)

Diffuser: step tempered glass

Gasket: molding shaped silicone seal

Note:

* Other CRI/CCT available on request

LED: Nichia, COB

CRI: Ra > 70

CCT:

CT30-3000K

CT60-6000K

Note: * Lm given in data is based on 4000K

LED driver:

Constant Voltage Input

Constant Current Output

Volt AC: 240V

Volt DC: 24V

Frequency: 50/60Hz

LED driver options:

ND - non-dimmable

PH - phase dimmable

010V - 0-10V dimmable

DALI - compatible

Application:

outdoors

floors/decks/pathways

landscapes

building facades

columns

Ambient Temp: -35°~+55°C



load capacity: 1195 kg

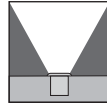
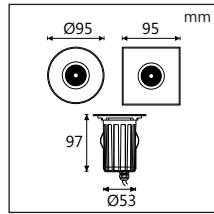
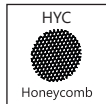

Ref Code	Watt	Volt	mA	Lm(±)
24.27.082.01.6.3	6.3W	24V DC	265	551
24.27.082.02.6.8	6.8W	240V AC	34	

Mounting box: ABS

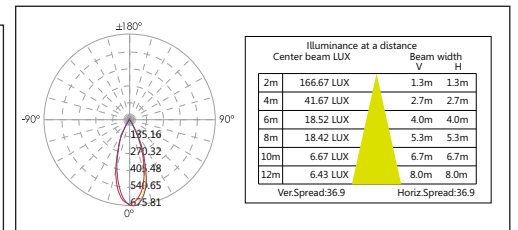
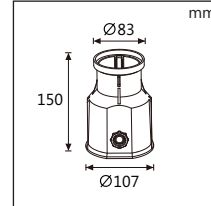

Beam Angle-Code:

18°-BA18

24°-BA24

32°-BA32



load capacity: 2526 kg

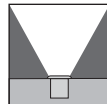
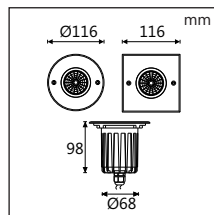
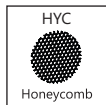

Ref Code	Watt	Volt	mA	Lm(±)
24.27.083.01.7.7	7.7W	24V DC	324	920
24.27.083.02.8.5	8.5W	240V AC	40	

Mounting box: ABS

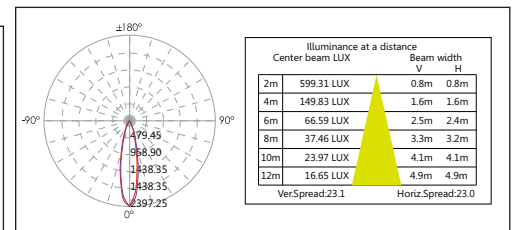
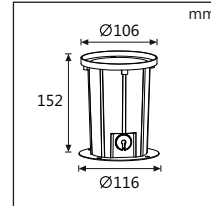

Beam Angle-Code:

15°-BA15

24°-BA24

38°-BA38

60°-BA60

buried up-lights

Mounting: buried in ground

Housing: die-cast powder coated aluminum

Trim: hard chrome-plated stainless steel 1.4401 (SUS316)

Diffuser: step tempered glass

Gasket: molding shaped silicone seal

Note:

* Other CRI/CCT available on request

LED: Cree

CRI: Ra > 70

CCT:

CT20-2000K

CT30-3000K

CT60-6000K

Note: * Lm given in data is based on 4000K

LED driver:

Constant Voltage Input

Constant Current Output

Volt AC: 240V

Volt DC: 24V

Frequency: 50/60Hz

LED driver options:

ND - non-dimmable

PH - phase dimmable

010V - 0-10V dimmable

DALI - compatible

Application:

outdoors

floors/decks/pathways

landscapes

building facades

columns

Ambient Temp: -35°~+55°C

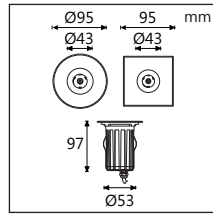
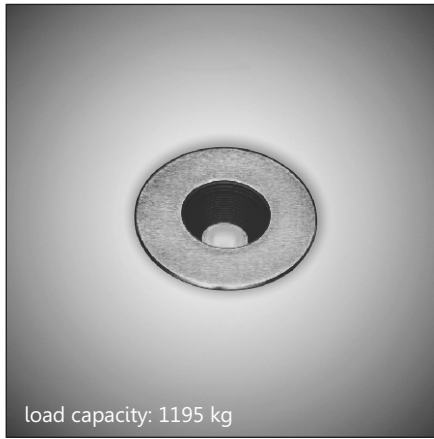

Ref Code	Watt	Volt	mA	Lm(±)
24.27.072.01.03	3W	24V DC	131	230
24.27.072.02.04	4W	240V AC	22	

Beam Angle: 20°

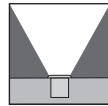

Beam Angle-Code:

- 9°-BA09
- 15°-BA15
- 20°-BA20
- 30°-BA30
- 45°-BA45
- 60°-BA60

Mounting box: ABS

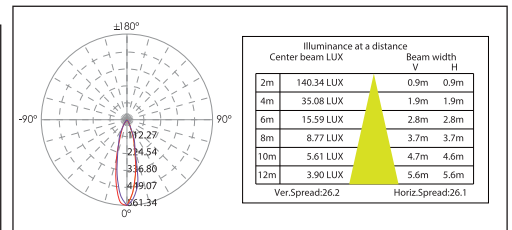
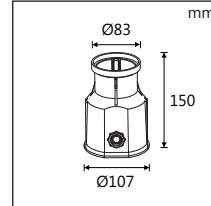

load capacity: 1195 kg

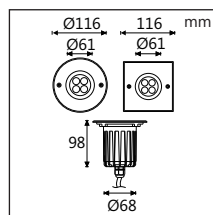
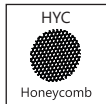

Ref Code	Watt	Volt	mA	Lm(±)
24.27.073.01.6.5	6.5W	24V DC	270	600
24.27.073.02.7.5	7.5W	240V AC	38	

Beam Angle: 20°

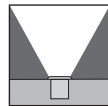

Beam Angle-Code:

- 10°-BA10
- 15°-BA15
- 20°-BA20
- 30°-BA30

Mounting box: ABS

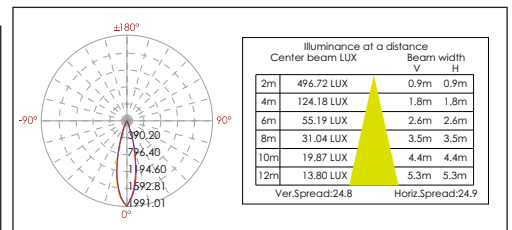
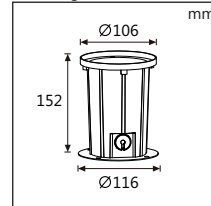

load capacity: 2526 kg

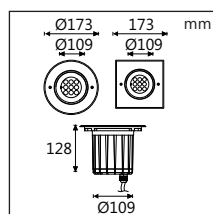
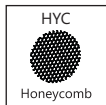

Ref Code	Watt	Volt	mA	Lm(±)
24.27.074.01.13	13W	24V DC	521	1000
24.27.074.02.13	13W	240V AC	64	

Beam Angle: 20°

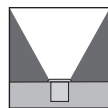

Beam Angle-Code:

- 10°-BA10
- 15°-BA15
- 20°-BA20
- 30°-BA30

Mounting box (RN): ABS

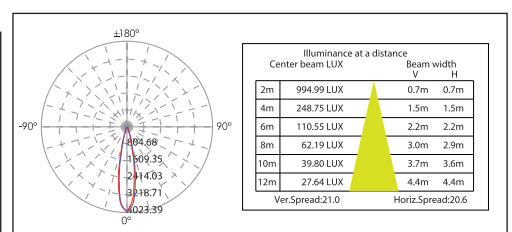
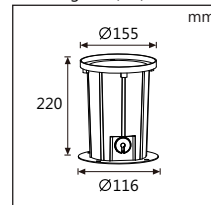

load capacity: 2500 kg

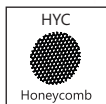

Mounting: buried in ground

Housing:

die-cast powder coated aluminum

Trim: hard chrome-plated
stainless steel 1.4401 (SUS316)

Diffuser: step tempered glass

Gasket: molding shaped silicone seal

Note:

* Other CRI/CCT available on request

LED: Cree

CRI: Ra > 70

CCT:

CT20-2000K

CT30-3000K

CT60-6000K

Note: * Lm given in
data is based on 4000K

LED driver:

Constant Voltage Input

Constant Current Output

Volt AC: 240V

Volt DC: 24V

Frequency: 50/60Hz

LED driver options:

ND - non-dimmable

PH - phase dimmable

010V - 0-10V dimmable

DALI - compatible

Application:

outdoors

floors/decks/pathways

landscapes

building facades

columns

Ambient Temp: -35° ~ +55°C



load capacity: 2961 kg

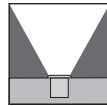
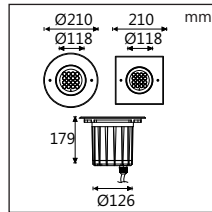
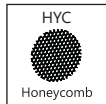

Ref Code

24.27.075.01.20

24.27.075.02.19

Watt

20W

19W

Volt

24V DC

240V AC

mA

830

84

Lm(±)

1200

Mounting box: ABS

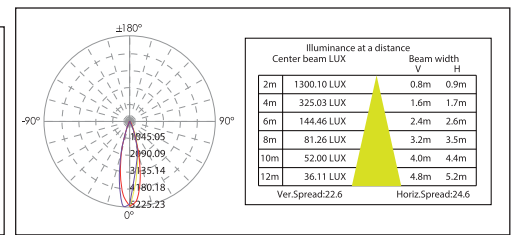
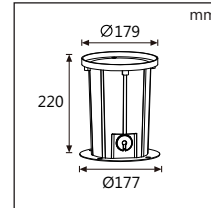

Beam Angle-Code:

10°-BA10

15°-BA15

20°-BA20

30°-BA30



load capacity: 5513 kg

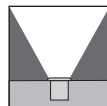
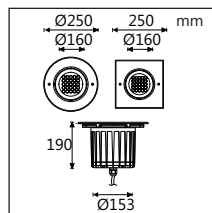
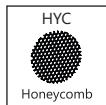

Ref Code

24.27.076.01.36

24.27.076.02.30

Watt

36W

30W

Volt

24V DC

240V AC

mA

131

22

Lm(±)

230

Mounting box: ABS

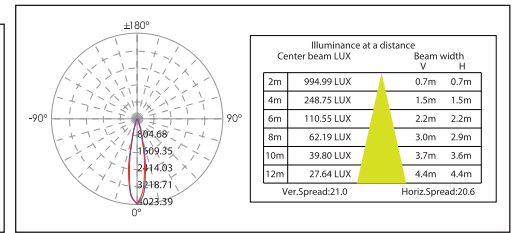
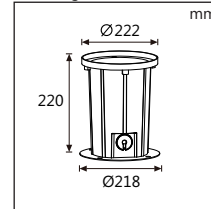

Beam Angle-Code:

10°-BA10

15°-BA15

20°-BA20

30°-BA30

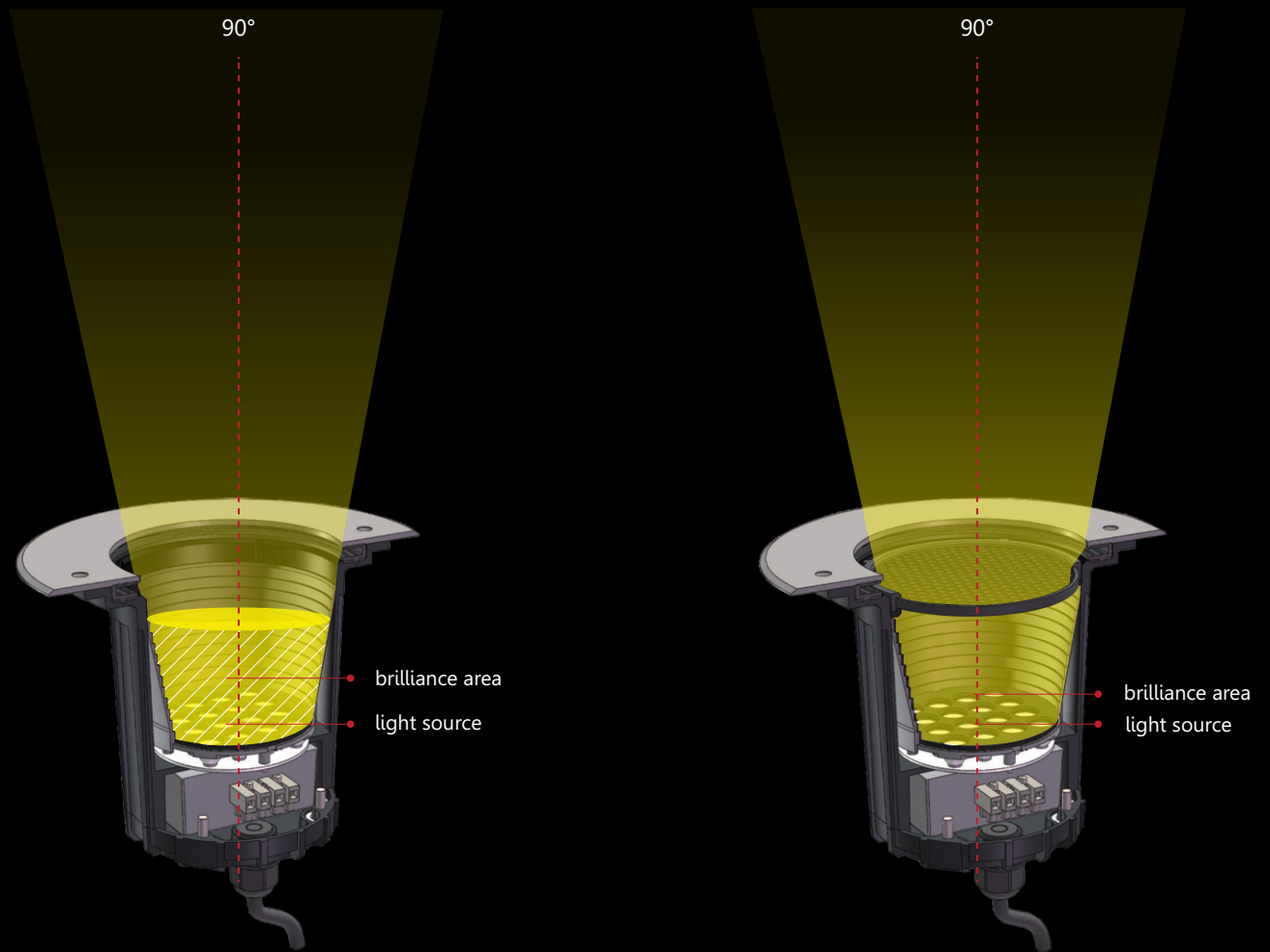

Mounting: buried in ground

Housing:

die-cast powder coated aluminum

Trim: hard chrome-plated stainless steel 1.4401 (SUS316)

Diffuser: step tempered glass

Gasket: molding shaped silicone seal

Note:

* Other CRI/CCT available on request

LED: Cree

CRI: Ra > 70

CCT:

CT20-2000K

CT30-3000K

CT60-6000K

Note: * Lm given in data is based on 4000K

LED driver:

Constant Voltage Input

Constant Current Output

Volt AC: 240V

Volt DC: 24V

Frequency: 50/60Hz

LED driver options:

ND - non-dimmable

PH - phase dimmable

010V - 0-10V dimmable

DALI - compatible

Application:

outdoors

floors/decks/pathways

landscapes

building facades

columns

Ambient Temp: -35°~+55°C

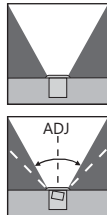
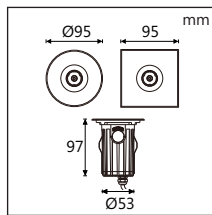

Ref Code	Watt	Volt	mA	Lm(±)
24.27.077.01.2.6	2.6W	24V DC	110	147
24.27.077.02.3.2	3.2W	240V AC	27	

Beam Angle-Code:

- 8°-BA08 12°x50°-BA12x50
- 13°-BA13 15°x32°-BA15x32
- 20°-BA20
- 25°-BA25

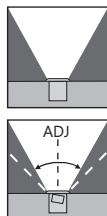
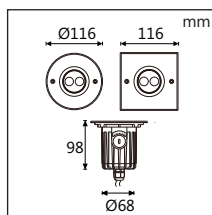
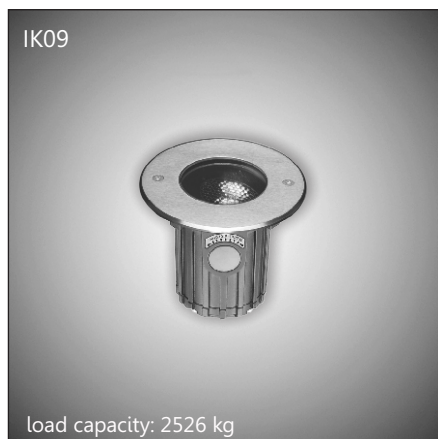
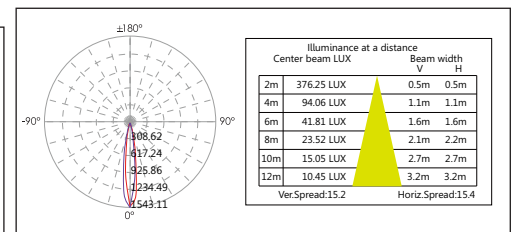
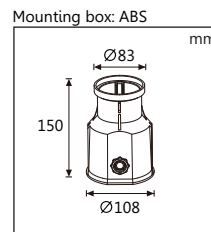

Ref Code	Watt	Volt	mA	Lm(±)
24.27.078.01.3.6	3.6W	24V DC	150	250
24.27.078.02.3.8	3.8W	240V AC	24	

Beam Angle-Code:

- 8°-BA08
- 15°-BA15
- 20°-BA20
- 50°-BA50

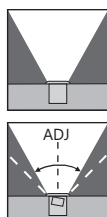
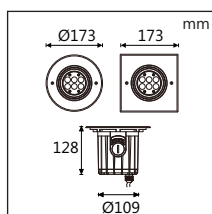
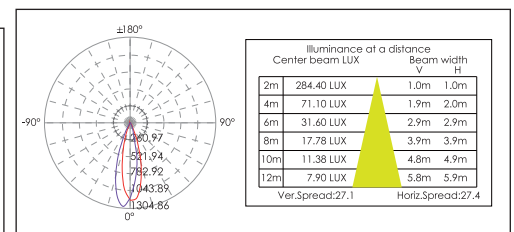
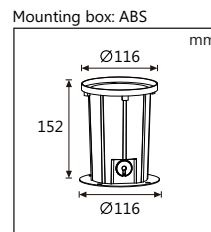

Ref Code	Watt	Volt	mA	Lm(±)
24.27.079.01.7.8	7.8W	24V DC	325	700
24.27.079.02.9.2	9.2W	240V AC	46	

Beam Angle-Code:

- 15°-BA15
- 20°-BA20
- 30°-BA30
- 50°-BA50

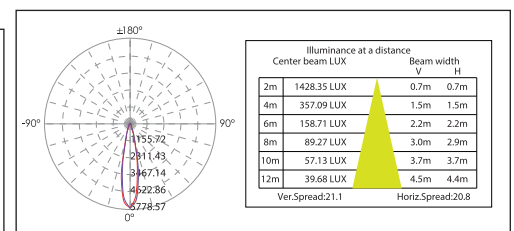
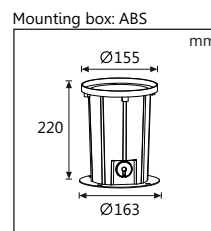

buried up-lights

Mounting: buried in ground
Housing: die-cast powder coated aluminum
Trim: hard chrome-plated stainless steel 1.4401 (SUS316)
Diffuser: step tempered glass
Gasket: molding shaped silicone seal
Note:
 * Other CRI/CCT available on request

LED: Cree
CRI: Ra > 70
CCT:
 CT20-2000K
 CT30-3000K
 CT60-6000K
Note: * Lm given in data is based on 4000K

LED driver:
 Constant Voltage Input
 Constant Current Output
Volt AC: 240V
Volt DC: 24V
Frequency: 50/60Hz
LED driver options:
 ND - non-dimmable
 PH - phase dimmable
 010V - 0-10V dimmable
 DALI - compatible

Application:
 outdoors
 floors/decks/pathways
 landscapes
 building facades
 columns
Ambient Temp: -35°~+55°C

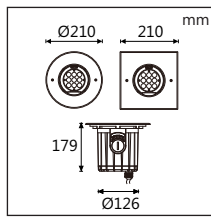

Ref Code	Watt	Volt	mA	Lm(±)
24.27.080.01.12	12W	24V DC	500	1090
24.27.080.02.13	13W	240V AC	64	

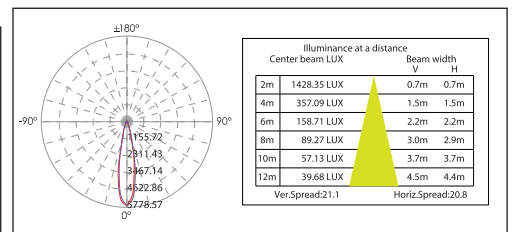
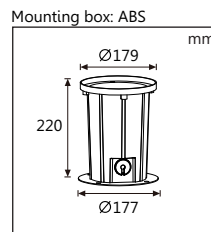
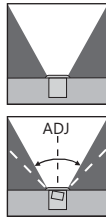

Beam Angle-Code:
 15°-BA15
 20°-BA20
 30°-BA30
 50°-BA50

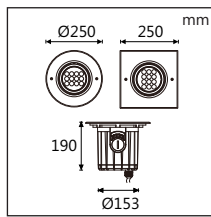

Ref Code	Watt	Volt	mA	Lm(±)
24.27.081.01.24.5	24.5W	24V DC	1020	1885
24.27.081.02.18.2	18.2W	240V AC	82	

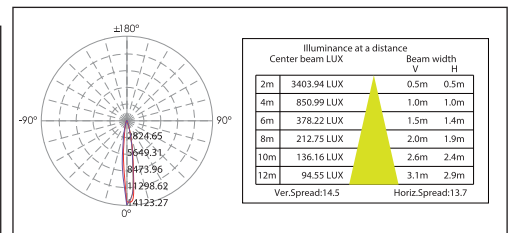
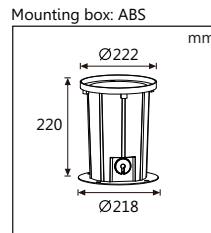
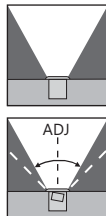

Beam Angle-Code:
 8°-BA08
 13°-BA13
 25°-BA25



buried up-lights

Mounting: buried in ground
Housing: die-cast powder coated aluminum
Trim: hard chrome-plated stainless steel 1.4401 (SUS316)
Diffuser: step tempered clear glass
Gasket: silicone

LED: SMD (Osram)
CRI: Ra>70-80
CCT: CT20-2000K
 CT30-3000K
 CT40-4000K
 CT50-5000K
 CT60-6000K
 RGB 3-in-1
 RGBW 4-in-1

LED driver options: integral/remote
Frequency: 50/60Hz
LED driver options: ND - non-dimmable
 PH - phase dimmable
 010V - 0-10V dimmable
 DALI - compatible

Application: outdoors
 floors/decks/pathways
 landscapes
 building facades
 columns
Ambient Temp: -35°~+55°C

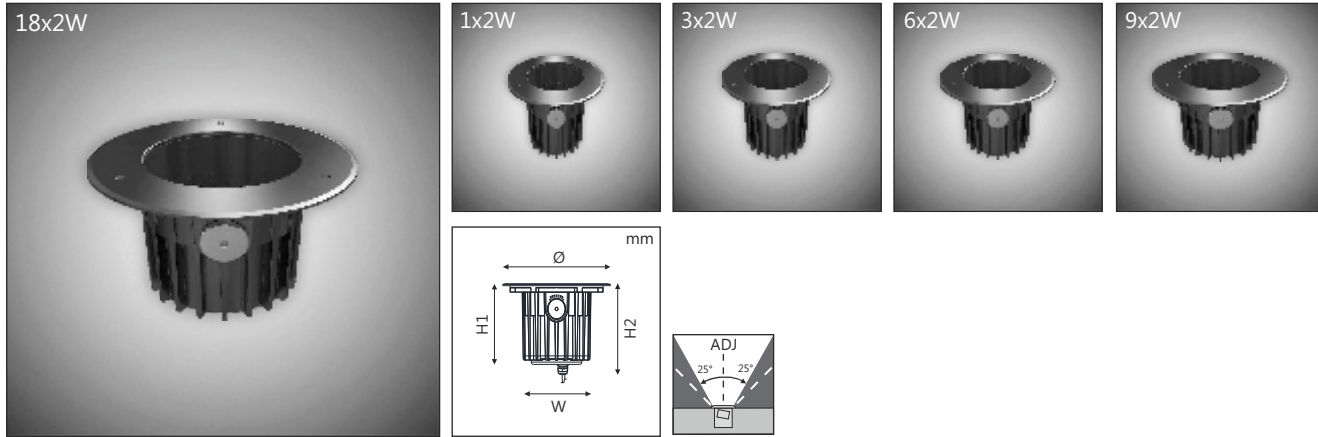

Ref Code	Watt	Volt	mA	Lm(±)	DiaxWxH1xH2	Mounting cylinder size, DiaxH	Load capacity,kg
24.70.054.01.02	1x2W	24V DC	110	130	90x78x86x100	85x116	1266
24.70.054.02.03	1x3W	240V AC	27	130	90x78x86x100	85x116	1266
24.70.055.01.06	3x2W	24V DC	279	400	130x80x103x116	119x135	783
24.70.055.02.06	3x2W	240V AC	25	400	130x80x103x116	119x135	783
24.70.056.01.12	6x2W	24V DC	508	800	160x140x123x144	148x154	2000
24.70.056.02.12	6x2W	240V AC	49	800	160x140x123x144	148x154	2000
24.70.057.01.18	9x2W	24V DC	750	1100	180x158x131x152	165x168	2000
24.70.057.02.18	9x2W	240V AC	70	1100	180x158x131x152	165x168	2000
24.70.058.01.24	12x2W	24V DC	1000	1600	210x186x150x171	193x193	2000
24.70.058.02.24	12x2W	240V AC	92	1600	210x186x150x171	193x193	2000
24.70.059.01.36	18x2W	24V DC	1575	2550	250x216x158x180	223x210	2000
24.70.059.02.36	18x2W	240V AC	150	2550	250x216x158x180	223x210	2000

Beam Angle-Code:

- 10°-BA10
- 25°-BA25
- 45°-BA45
- 60°-BA60

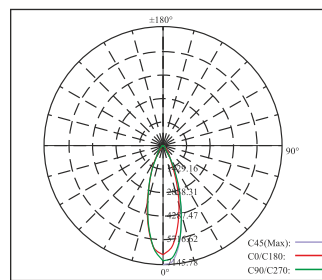

Illuminance at a Distance

Center Beam LUX	Beam Width V	Beam Width H
2m: 1641.40 LUX	1.1m	1.1m
4m: 410.35 LUX	2.3m	2.3m
6m: 182.38 LUX	3.4m	3.4m
8m: 102.59 LUX	4.6m	4.6m
10m: 65.66 LUX	5.7m	5.7m
12m: 45.59 LUX	6.9m	6.8m

Vert.Spread:32.1 Horiz.Spread:31.8

Mounting cylinder:

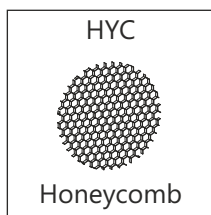
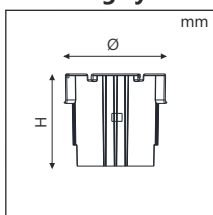

Notes:

- * Lm given in data is based on 3000K
- * Other CRI/CCT available on request

Light distribution curve(Unit:cd)

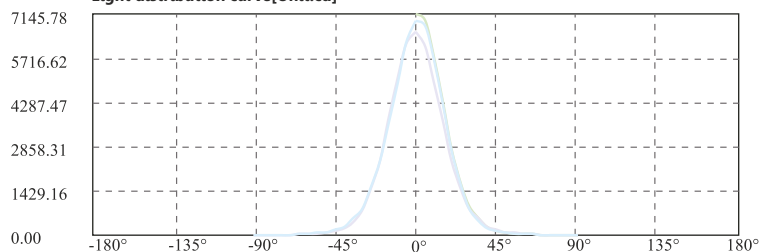

Power cable:

- H05RN-F 2X1.0mm² L=0.5m (low voltage)
- H05RN-F 3X0.75mm² L=0.5m (high voltage)
- H05RN-F 4X0.75mm² L=0.5m (RGB)

Mounting:
buried in ground
Housing:
die-cast aluminum
Trim:
die-cast aluminum
Diffuser: tempered glass

LED: Cree
CRI: Ra > 80 (±3000K)
CCT:
CT30-3000K
CT40-4000K
Note: * Lm given in data is based on 3000K

LED driver options:
integral/remote
Volt DC: 24V
Volt AC: 220-240V
Frequency: 50-60Hz
LED driver options:
ND - non-dimmable
PH - phase dimmable
010V - 0-10V dimmable
DALI - compatible

Application:
outdoors
floors/decks/pathways
landscapes
building facades
columns
Ambient Temp: -35°~+55°C



	mm	Ref Code	Watt	Volt	mA	Lm(±)
		24.08.120.01.08	4x2.1W	24V DC	700	857
		24.08.120.02.08	4x2.1W	240V AC	700	857
						Beam Angle-Code: 6°-BA06 13°-BA13 20°-BA20 30°-BA30 40°-BA40 10°x35°-BA10x35 20°x40°-BA20x40
		24.08.121.01.12	6x2.1W	24V DC	700	1285
		24.08.121.02.13	6x2.1W	240V AC	700	1285
						Beam Angle-Code: 6°-BA06 13°-BA13 20°-BA20 30°-BA30 40°-BA40 10°x35°-BA10x35 20°x40°-BA20x40
		24.08.122.01.19	9x2.1W	24V DC	700	1930
		24.08.122.02.19	9x2.1W	240V AC	700	1930
						Beam Angle-Code: 6°-BA06 13°-BA13 20°-BA20 30°-BA30 40°-BA40 10°x35°-BA10x35 20°x40°-BA20x40
		24.08.123.01.25	12x2.1W	24V DC	700	2570
		24.08.123.02.25	12x2.1W	240V AC	700	2570
						Beam Angle-Code: 6°-BA06 13°-BA13 20°-BA20 30°-BA30 40°-BA40 10°x35°-BA10x35 20°x40°-BA20x40

Mounting:
buried in ground
Housing:
die-cast aluminum
Trim:
die-cast aluminum
Diffuser: tempered glass

LED: Cree
CRI: Ra>80 (±3000K)
 CCT:
CT30-3000K
CT40-4000K
Note: * Lm given in
data is based on 3000K

LED driver options:
integral/remote
Volt DC: 24V
Volt AC: 220-240V
Frequency: 50-60Hz
LED driver options:
ND - non-dimmable
PH - phase dimmable
010V - 0-10V dimmable
DALI - compatible

Application:
outdoors
floors/decks/pathways
landscapes
building facades
columns
Ambient Temp: -35°~+55°C



	mm	Ref Code	Watt	Volt	mA	Lm(±)
		24.08.128.01.08	4x2.1W	24V DC	700	857
	24.08.128.02.08	4x2.1W	240V AC	700	857	
		Beam Angle-Code:				
		6°-BA06 13°-BA13 20°-BA20 30°-BA30 40°-BA40 10°x35°-BA10x35 20°x40°-BA20x40				
		24.08.129.01.12	6x2.1W	24V DC	700	1285
	24.08.129.02.13	6x2.1W	240V AC	700	1285	
		Beam Angle-Code:				
		6°-BA06 13°-BA13 20°-BA20 30°-BA30 40°-BA40 10°x35°-BA10x35 20°x40°-BA20x40				
		24.08.130.01.19	9x2.1W	24V DC	700	1930
	24.08.130.02.19	9x2.1W	240V AC	700	1930	
		Beam Angle-Code:				
		6°-BA06 13°-BA13 20°-BA20 30°-BA30 40°-BA40 10°x35°-BA10x35 20°x40°-BA20x40				
		24.08.131.01.25	12x2.1W	24V DC	700	2570
	24.08.131.02.25	12x2.1W	240V AC	700	2570	
		Beam Angle-Code:				
		6°-BA06 13°-BA13 20°-BA20 30°-BA30 40°-BA40 10°x35°-BA10x35 20°x40°-BA20x40				

Mounting:
buried in ground
Housing:
die-cast aluminum
Trim:
die-cast aluminum
Diffuser: tempered glass

LED: Cree
CRI: Ra>80 (±3000K)
CCT:
CT30-3000K
CT40-4000K
Note: * Lm given in data is based on 3000K

LED driver options:
integral/remote
Volt AC: 220-240V
Frequency: 50-60Hz
LED driver options:
ND - non-dimmable
PH - phase dimmable
010V - 0-10V dimmable
DALI - compatible

Application:
outdoors
floors/decks/pathways
landscapes
building facades
columns
Ambient Temp: -35°~+55°C

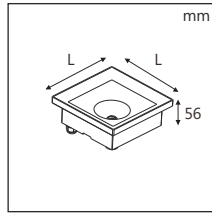

Ref Code	Watt	mA	Lm(±)	LxL
24.08.140.01.06	1x6.1W	350	800	91
24.08.142.01.12	1x12.2W	350	1590	123
24.08.142.01.18	1x17.6W	500	2040	160
24.08.143.01.25	1x24.6W	700	2850	200

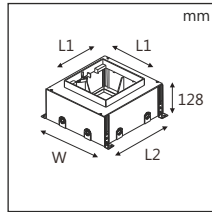

Mounting box
DiaxLxW:
97x170x161
129x170x161
166x250x234
206x250x234

Beam Angle-Code:

6W	18W
15°-BA15	24°-BA24
22°-BA22	34°-BA34
33°-BA33	46°-BA46
50°-BA50	25W
12W	24°-BA24
24°-BA24	38°-BA38
40°-BA40	60°-BA60

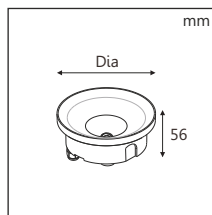
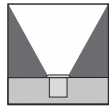

Ref Code	Watt	mA	Lm(±)	Dia
24.08.144.01.06	1x6.1W	350	800	92
24.08.145.01.12	1x12.2W	350	1590	125
24.08.146.01.18	1x17.6W	500	2040	160
24.08.147.01.25	1x24.6W	700	2850	200

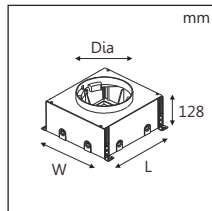

Mounting box
L1xL2xW:
97x170x161
129x170x161
166x250x234
206x250x234

Beam Angle-Code:

6W	18W
15°-BA15	24°-BA24
22°-BA22	34°-BA34
33°-BA33	46°-BA46
50°-BA50	25W
12W	24°-BA24
24°-BA24	38°-BA38
40°-BA40	60°-BA60

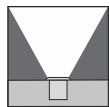

buried up-lights

Mounting:
buried in ground
Housing:
die-cast aluminum
Trim:
hard chrome-plated
stainless steel 1.4401 (SUS316)
Diffuser: tempered glass

LED: Cree
CRI: Ra>80 (±3000K)
CCT:
CT30-3000K
CT40-4000K
Note: * Lm given in
data is based on 3000K

LED driver options:
integral/remote
Volt DC: 24V
Volt AC: 220-240V
Frequency: 50-60Hz
LED driver options:
ND - non-dimmable
PH - phase dimmable
010V - 0-10V dimmable
DALI - compatible

Application:
outdoors
floors/decks/pathways
landscapes
building facades
columns
Ambient Temp: -35°~+55°C



	mm	Ref Code	Watt	Volt	mA	Lm(±)
		24.08.116.01.08	4x2.1W	24V DC	700	857
	24.08.116.02.08	4x2.1W	240V AC	700	857	
		Beam Angle-Code:				
		6°-BA06 13°-BA13 20°-BA20 30°-BA30 40°-BA40 10°x35°-BA10x35 20°x40°-BA20x40				
		24.08.117.01.12	6x2.1W	24V DC	700	1285
	24.08.117.02.13	6x2.1W	240V AC	700	1285	
		Beam Angle-Code:				
		6°-BA06 13°-BA13 20°-BA20 30°-BA30 40°-BA40 10°x35°-BA10x35 20°x40°-BA20x40				
		24.08.118.01.19	9x2.1W	24V DC	700	1930
	24.08.118.02.19	9x2.1W	240V AC	700	1930	
		Beam Angle-Code:				
		6°-BA06 13°-BA13 20°-BA20 30°-BA30 40°-BA40 10°x35°-BA10x35 20°x40°-BA20x40				
		24.08.119.01.25	12x2.1W	24V DC	700	2570
	24.08.119.02.25	12x2.1W	240V AC	700	2570	
		Beam Angle-Code:				
		6°-BA06 13°-BA13 20°-BA20 30°-BA30 40°-BA40 10°x35°-BA10x35 20°x40°-BA20x40				

Mounting:
buried in ground
Housing:
die-cast aluminum
Trim:
hard chrome-plated
stainless steel 1.4401 (SUS316)
Diffuser: tempered glass

LED: Cree
CRI: Ra > 80 (±3000K)
CCT:
CT30-3000K
CT40-4000K
Note: * Lm given in
data is based on 3000K

LED driver options:
integral/remote
Volt DC: 24V
Volt AC: 220-240V
Frequency: 50-60Hz
LED driver options:
ND - non-dimmable
PH - phase dimmable
010V - 0-10V dimmable
DALI - compatible

Application:
outdoors
floors/decks/pathways
landscapes
building facades
columns
Ambient Temp: -35°~+55°C



		Ref Code	Watt	Volt	mA	Lm(±)
		24.08.124.01.08	4x2.1W	24V DC	700	857
		24.08.124.02.08	4x2.1W	240V AC	700	857
						Beam Angle-Code: 6°-BA06 13°-BA13 20°-BA20 30°-BA30 40°-BA40 10°x35°-BA10x35 20°x40°-BA20x40
		24.08.125.01.12	6x2.1W	24V DC	700	1285
		24.08.125.02.13	6x2.1W	240V AC	700	1285
						Beam Angle-Code: 6°-BA06 13°-BA13 20°-BA20 30°-BA30 40°-BA40 10°x35°-BA10x35 20°x40°-BA20x40
		24.08.126.01.19	9x2.1W	24V DC	700	1930
		24.08.126.02.19	9x2.1W	240V AC	700	1930
						Beam Angle-Code: 6°-BA06 13°-BA13 20°-BA20 30°-BA30 40°-BA40 10°x35°-BA10x35 20°x40°-BA20x40
		24.08.127.01.25	12x2.1W	24V DC	700	2570
		24.08.127.02.25	12x2.1W	240V AC	700	2570
						Beam Angle-Code: 6°-BA06 13°-BA13 20°-BA20 30°-BA30 40°-BA40 10°x35°-BA10x35 20°x40°-BA20x40



Mounting: buried in ground
Housing: high pressure die-cast aluminum
Stainless steel trim: 1.4401 (SUS316)
Trim options:
 -round (RN)
 -square (SQ)
Diffuser: 8mm tempered glass
Note:
 * Other CRI/CCT available on request

LED: SMD/COB (CREE)
CRI:
 Ra>80 (±3000K)
 Ra>75 (±4000K)
CCT:
 CT30-3000K/CT35-3500K
 CT40-4000K/CT45-4500K
 RGB
Lumen range:
 75 lm/w (±3000K)

LED driver: integral/remote
Frequency: 50/60Hz
LED driver options:
 ND - non-dimmable
 PH - phase dimmable
 010V - 0-10V dimmable
 DALI - compatible
 DMX512 - compatible

Application:
 outdoors, landscapes
 roads/pathways
 building facades, columns
Ambient Temp: -25°~+55°C
Ambient humidity: 10%~50%

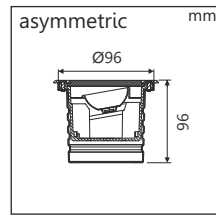
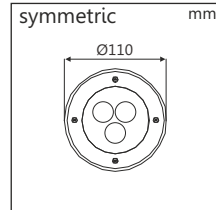

Ref Code	Watt	Volt	LED	LED Color	Beam
24.26.014.01.3.5	3.5W	AC240V	SMD(x3)	WH	symmetric
24.26.014.06.3.5	3.5W	DC12-24V	SMD(x3)	WH	symmetric
24.26.014.04.3.5	3.5W	DC12-24V	SMD(x3)	RGB	symmetric
24.26.014.02.06	6W	AC240V	SMD(x3)	WH	symmetric
24.26.014.07.06	6W	DC12-24V	SMD(x3)	WH	symmetric
24.26.014.05.06	6W	DC12-24V	SMD(x3)	RGB	symmetric
24.26.014.03.06	6W	AC240V	COB(x1)	WH	asymmetric
24.26.014.08.06	6W	DC12-24V	COB(x1)	WH	asymmetric

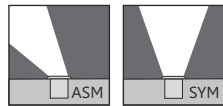

Beam Angle-Code:

- SYM:**
 5°-BA05
 12°-BA12
 20°-BA20
 30°-BA30
 45°-BA45
ASM: 25°-BA25°

Notes:

- * RGB-DC 24V-DMX512
- * lm output mentioned is based on delivered lm output data

Ordering Guide:

24.26.014.03.06+SQ+ASM+CT30+BA25+ND
 (item+square asymmetric+CCT+beam angle+driver)

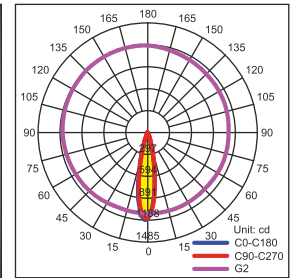
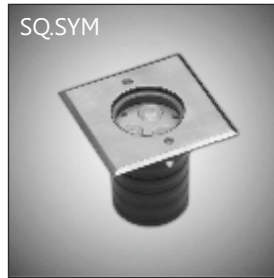

buried up-lights

Mounting: buried in ground
Housing: die-cast aluminum
Trim: stainless steel 1.4401 (SUS316)
Fixing springs: stainless steel 1.4401 (SUS316)
Diffuser: tempered glass
Note:
 * Other CRI/CCT available on request

LED: CREE/Edison
CRI: Ra>80
CCT: CT30-3000K/CT40-4000K
 CT50-5000K/CT60-6000K
 RGB/RGBW/Amber
Lumen output: 108 Lm/W
Note:
 * Lm given in data is based on 3000K

LED driver: integral/remote
Frequency: 50/60Hz
LED driver options:
 ND - non-dimmable
 PH - phase dimmable
 010V - 0-10V dimmable
 DALI - compatible
Notes:
 * IP65 with integral drivers
 * IP68 with remote drivers

Application:
 outdoors
 floors/decks/pathways
 fountains
 landscapes
 building facades
Ambient Temp: -35°~+55°C

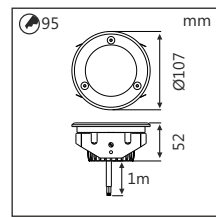

Ref Code	Watt	Volt	IP
24.31.017.01.06	6W (WH, CREE)	CC, 350mA	68
24.31.017.02.06	6W (WH, CREE)	CV, 24V DC	68
24.31.017.03.06	6W (RGB, Edison)	CC, 350mA	65
24.31.017.04.06	6W (WH, CREE)	240V AC	65

Note:
 *glass thickness is 8 mm
 *fixed single colors available:
 red, green, blue, amber
Beam Angle-Code:
 10°-BA10
 40°-BA40
 120°-BA120 (with opal glass)

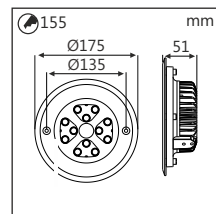
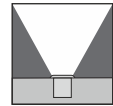

Ref Code	Watt	Volt	IP
24.31.018.01.12	12W (WH, Edison)	CV, 24V DC	68
24.31.018.02.12	12W (WH, CREE)	CC, 350mA	68
24.31.018.03.12	12W (WH, CREE)	CV, 24V DC	68
24.31.018.04.12	12W (RGB, Edison)	CC, 350mA	68
24.31.018.05.10	10W (WH, CREE)	240V AC	65
24.31.018.06.12	12W (WH, CREE)	240V AC	65

Beam Angle-Code:
 10°-BA10
 20°-BA20
 40°-BA40
 60°-BA60
 120°-BA120 (24.31.018.01, opal glass)
Note:
 *glass thickness is 10 mm
 *fixed single colors available:
 red, green, blue, amber

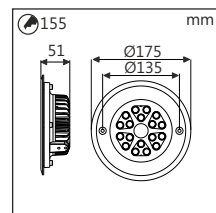
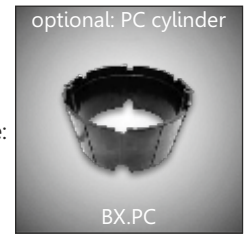
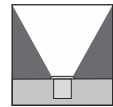

Ref Code	Watt	Volt	IP
24.31.019.01.18	18W (WH, CREE)	CC, 350mA	68
24.31.019.02.18	18W (WH, CREE)	CV, 24V DC	68
24.31.019.03.18	18W (RGB, Edison)	CC, 350mA	68
24.31.019.04.18	18W (WH, CREE)	240V AC	65

Beam Angle-Code:
 10°-BA10
 20°-BA20
 40°-BA40
 60°-BA60
Note:
 *glass thickness is 10 mm
 *fixed single colors available:
 red, green, blue, amber

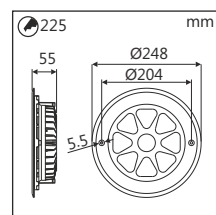
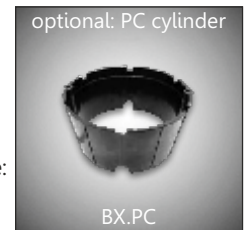
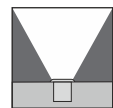

Ref Code	Watt	Volt	IP
24.31.020.01.18	18W (WH, CREE)	CV, 24V DC	68
24.31.020.02.24	24W (WH, CREE)	CC, 350mA	68
24.31.020.03.24	24W (WH, CREE)	CV, 24V DC	68
24.31.020.04.24	24W (RGB, Edison)	CC, 350mA	68
24.31.020.05.18	18W (WH, CREE)	240V AC	65
24.31.020.06.24	24W (WH, CREE)	240V AC	65

Beam Angle-Code:
 10°-BA10
 20°-BA20
 40°-BA40
 60°-BA60
 120°-BA120 (18W, opal glass)
Note:
 *glass thickness is 12 mm
 *fixed single colors available:
 red, green, blue, amber

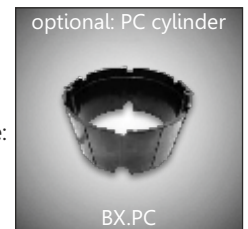
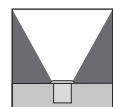

Mounting:
buried in ground
Housing:
die-cast aluminum
Trim:
hard chrome-plated
stainless steel 1.4401 (SUS316)
Diffuser: tempered glass

LED: Cree
CRI: Ra>80 (±3000K)
CCT:
CT30-3000K
CT40-4000K
Note: * Lm given in
data is based on 3000K

LED driver options:
integral/remote
Volt AC: 220-240V
Frequency: 50-60Hz
LED driver options:
ND - non-dimmable
PH - phase dimmable
010V - 0-10V dimmable
DALI - compatible

Application:
outdoors
floors/decks/pathways
landscapes
building facades
columns
Ambient Temp: -35°~+55°C

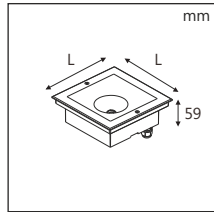

Ref Code	Watt	mA	Lm(±)	LxL
24.08.132.01.06	1x6.1W	350	800	100
24.08.133.01.12	1x12.2W	350	1590	135
24.08.134.01.18	1x17.6W	500	2040	170
24.08.135.01.25	1x24.6W	700	2850	210

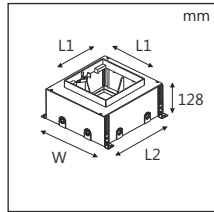

**Mounting box
DiaxLxW:**
97x170x161
129x170x161
166x250x234
206x250x234

Beam Angle-Code:

6W	18W
15°-BA15	24°-BA24
22°-BA22	34°-BA34
33°-BA33	46°-BA46
50°-BA50	25W
12W	24°-BA24
24°-BA24	38°-BA38
40°-BA40	60°-BA60

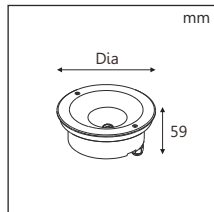
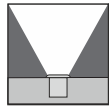

Ref Code	Watt	mA	Lm(±)	Dia
24.08.136.01.06	1x6.1W	350	800	100
24.08.137.01.12	1x12.2W	350	1590	135
24.08.138.01.18	1x17.6W	500	2040	170
24.08.139.01.25	1x24.6W	700	2850	210

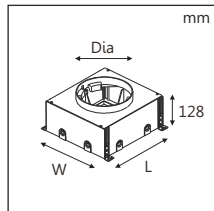

**Mounting box
L1xL2xW:**
97x170x161
129x170x161
166x250x234
206x250x234

Beam Angle-Code:

6W	18W
15°-BA15	24°-BA24
22°-BA22	34°-BA34
33°-BA33	46°-BA46
50°-BA50	25W
12W	24°-BA24
24°-BA24	38°-BA38
40°-BA40	60°-BA60

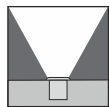



Mounting: buried in ground

Housing:

die-cast powder coated aluminum

Trim: hard chrome-plated stainless steel 1.4401 (SUS316)

Diffuser: step tempered glass

Gasket: molding shaped silicone seal

Note:

* Other CRI/CCT available on request

LED: Osram

CRI: Ra>70

CCT:

CT30-3000K

CT40-4000K

CT50-5000K

CT60-6000K

RGB

RGBW

Amber

LED driver:

integral/remote

Volt AC: 240V

Volt DC: 24V

Frequency: 50/60Hz

Power Cable:

(DC 24V) 2x1.0mm²/L=2.0m

(AC 220V) 3x1.0mm²/L=2.0m

(RGB) 4x0.75mm²/L=0.5m

Application:

outdoors

floors/decks/pathways

landscapes

building facades

columns

Ambient Temp: -35°~+55°C

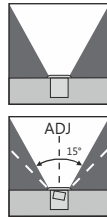
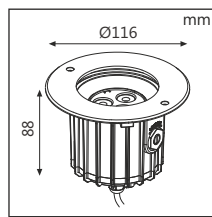

Ref Code	Watt	Volt	mA	Lm(±)
24.27.021.01.03	3x1W	24V DC	131	230
24.27.021.02.03	3x1W	240V AC	40	

Beam Angle-Code:

15°-BA15

20°-BA20

30°-BA30

45°-BA45

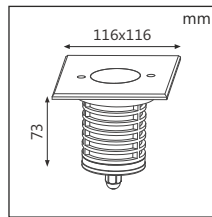
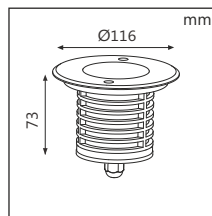
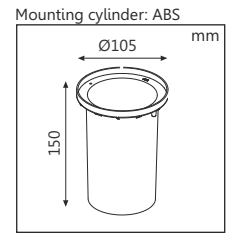

Ref Code	Watt	Volt	mA	Lm(±)
24.27.022.01.1.2	1.2W	24V DC	51	17
24.27.022.02.1.8	1.8W	240V AC	17	
24.27.022.03.1.2	1.2W(3-in-1)	24V DC(R/G/B)	51	

Beam Angle: > 120°

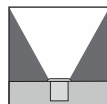
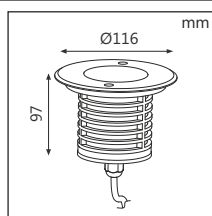
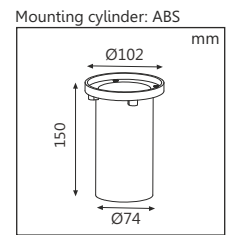
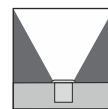

Ref Code	Watt	Volt	mA	Lm(±)
24.27.023.01.06	6W(RGBW 4-in-1)	24V DC	338	220

Beam Angle-Code:

RGBW

15°-BA15

22°-BA22

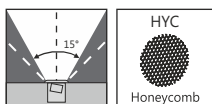
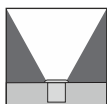
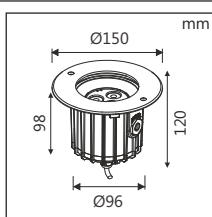
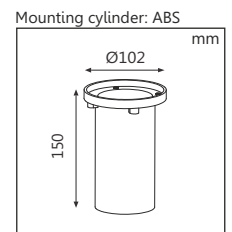

Ref Code	Watt	Volt	mA	Lm(±)
24.27.024.01.06	3x2W	24V DC	236	400
24.27.024.02.06	3x2W	240V AC	30	400
24.27.024.03.06	4x1.5W (RGB 3-in-1)	24V DC(R/G/B)	125	90

Beam Angle-Code:
symmetric (SYM)

15°-BA15

20°-BA20

30°-BA30

45°-BA45

RGB

30°-BA30

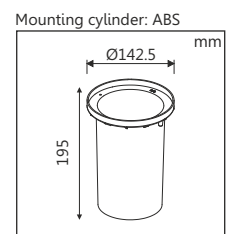

Mounting: buried in ground
Housing: die-cast powder coated aluminum
Trim: hard chrome-plated stainless steel 1.4401 (SUS316)
Diffuser: step tempered glass
Gasket: molding shaped silicone seal
Note:
 * Other CRI/CCT available on request

LED: Osram
CRI: Ra>70
CCT:
 CT30-3000K
 CT40-4000K
 CT50-5000K
 CT60-6000K
 RGB
 RGBW
 Amber

LED driver:
 integral/remote
Volt AC: 240V
Volt DC: 24V
Frequency: 50/60Hz
LED driver options:
 ND - non-dimmable
 PH - phase dimmable
 010V - 0-10V dimmable
 DALI - compatible

Application:
 outdoors
 floors/decks/pathways
 landscapes
 building facades
Ambient Temp: -35°~+55°C

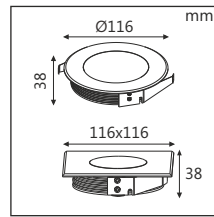
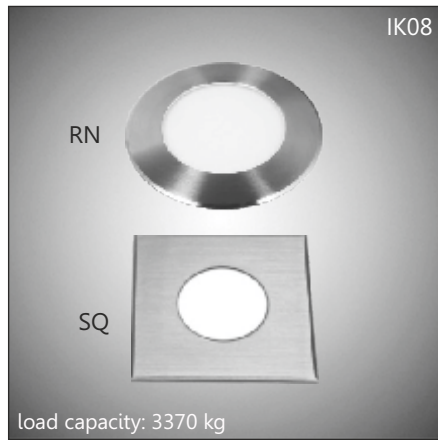
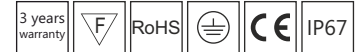

Ref Code	Watt	Volt	mA	Lm(±)
24.27.025.01.1.2	1.2W(12xSMD5050)	24V DC	34	20
24.27.025.02.1.2	1.2W(12xSMD5050)	240V AC	17	
24.27.025.03.1.7	1.7W(24xRGBW)	24V DC(R/G/B/W)	17/18/17/17	

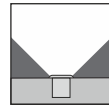

Beam Angle: 120°

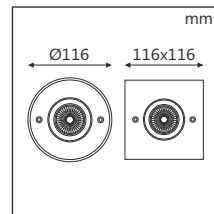
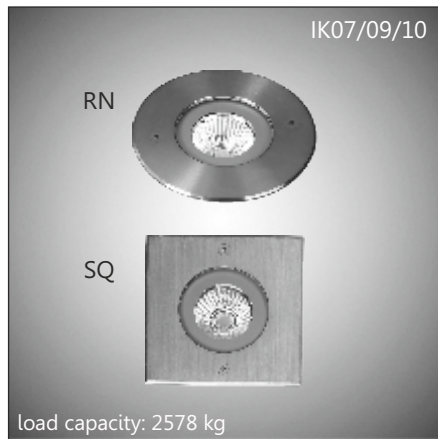
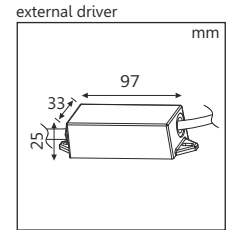

Ref Code	Watt	Volt	mA	Lm(±)
24.27.026.01.06	6W	24V DC	270	530
24.27.026.02.06	6W	240V AC	35	

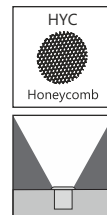
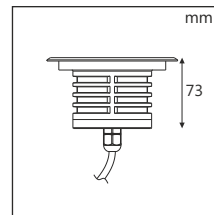

Beam Angle-Code:
 18°-BA18
 25°-BA25
 40°-BA40

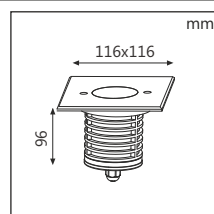
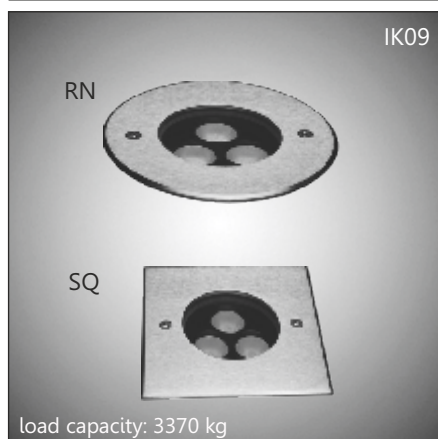
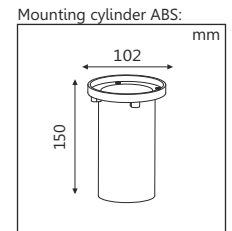

Ref Code	Watt	Volt	mA	Lm(±)
24.27.027.01.06	3x2W	24V DC	236	400
24.27.027.02.06	3x2W	240V AC	30	
24.27.027.03.06	3x2W(RGB 3-in-1)	24V DC(R/G/B)	70/124/124	

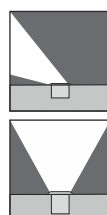
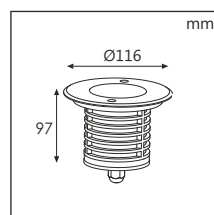

Beam Angle-Code:
SYM
 15°-BA15
 20°-BA20
 30°-BA30
 45°-BA45
ASM
 35°-BA35
 45°-BA45
RGB
 30°-BA30

Lens-Code:
 symmetric-SYM
 asymmetric-ASM

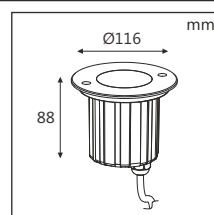
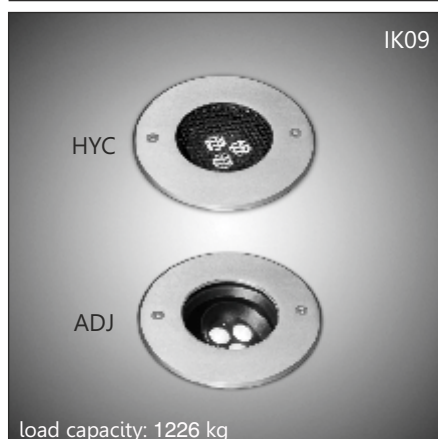
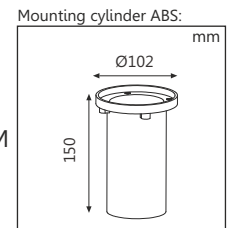

Ref Code	Watt	Volt	mA	Lm(±)
24.27.028.01.03	3x1W	24V DC	131	300
24.27.028.02.03	3x1W	240V AC	40	

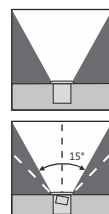

Beam Angle-Code:
 15°-BA15
 20°-BA20
 30°-BA30

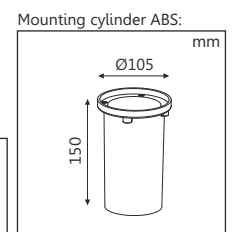
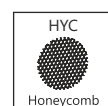

Mounting: buried in ground
Housing: die-cast powder coated aluminum
Trim: hard chrome-plated stainless steel 1.4401 (SUS316)
Diffuser: clear/frosted step tempered glass
Gasket: molding shaped silicone seal

LED: SMD/COB (Osram)
CRI: Ra>80
CCT: CT30-3000K
 CT40-4000K
 CT50-5000K
 CT60-6000K
 RGB/RGBW/Amber
Note: * Other CRI/CCT available on request

LED driver: integral/remote
Volt AC: 240V
Volt DC: 24V
Frequency: 50/60Hz
Power Cable: (DC 24V) 2x1.0mm²/L=2.0m
 (AC 220V) 3x1.0mm²/L=2.0m
 (RGB) 4x0.75mm²/L=0.5m

Application: outdoors
 floors/decks/pathways
 landscapes
 building facades
Ambient Temp: -35°~+55°C

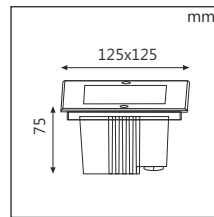
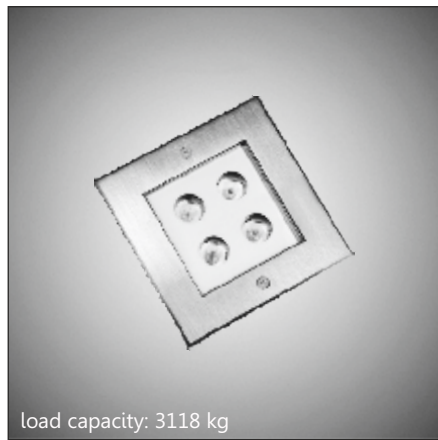

Ref Code	Watt	Volt	mA	Lm(±)
24.27.029.01.04	4x1W	24V DC	188	350
24.27.029.02.04	4x1W	240V AC	42	

Lens-Code:
 symmetric-SYM
 asymmetric-ASM

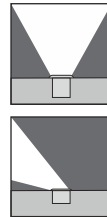

Beam Angle-Code:

SYM	ASM
15°-BA15	35°-BA35
20°-BA20	45°-BA45
30°-BA30	
45°-BA45	

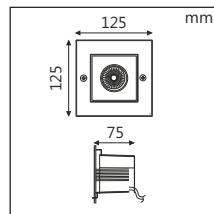
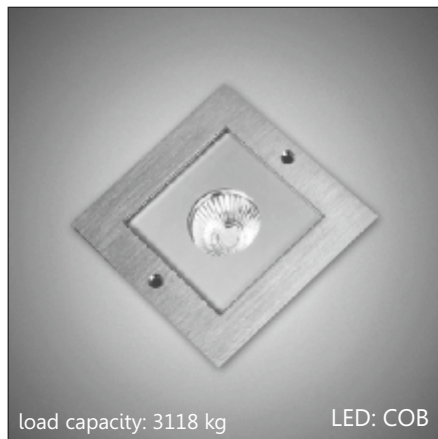
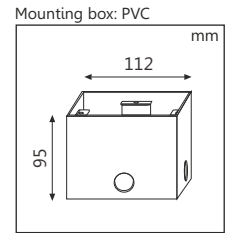

Ref Code	Watt	Volt	mA	Lm(±)
24.27.030.01.06	1x6W	24V DC	270	550
24.27.030.02.06	1x6W	240V AC	60	

Beam Angle-Code:
 18°-BA18
 25°-BA25
 40°-BA40

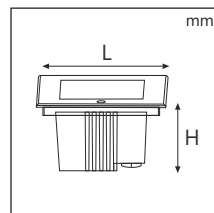
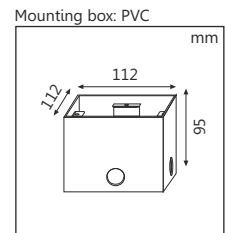
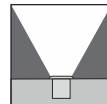

Ref Code	Watt	Volt	mA	Lm(±)	LxH
24.27.031.01.3.2	3.2W(25xSMD 3020)	240V AC	30	150	125x75
24.27.032.01.3.3	3.3W(36xSMD 3020)	240V AC	31		160x79

Beam Angle:120°

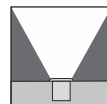

LxH (mounting box)
 112x95
 152x116

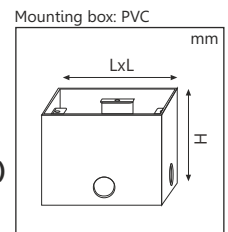

Mounting:
buried in ground
Housing:
die-cast powder coated aluminum
Trim: hard chrome-plated
stainless steel 1.4401 (SUS316)
Diffuser:
step tempered glass
Gasket:
molding shaped silicon seal

LED: COB (Osram)
CRI: Ra>80
CCT:
CT30-3000K
CT40-4000K
CT50-5000K
CT60-6000K
RGB/RGBW/Amber
Note: * Other CRI/CCT
available on request

LED driver:
integral/remote
Volt AC: 240V
Volt DC: 24V
Frequency: 50/60Hz
Power Cable:
(DC 24V) 2x1.0mm²/L=2.0m
(AC 220V) 3x1.0mm²/L=2.0m
(RGB) 4x0.75mm²/L=0.5m
(RGBW) 5x0.5mm²/L=0.5m

Application:
outdoors
floors/decks/pathways
landscapes
building facades
Ambient Temp: -35°~+55°C

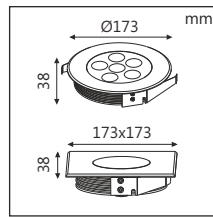
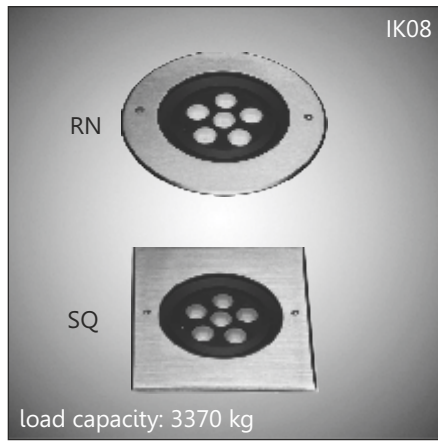

Ref Code	Watt	Volt	mA	Lm(±)
24.27.040.01.12	6x2W	24V DC	541	800
24.27.040.02.12	6x2W	240V AC	64	
24.27.040.03.12	6x2W(RGB 3-in-1)	24V DC(R/G/B)	221/257/253	

Lens-Code:
symmetric-SYM
asymmetric-ASM

Beam Angle-Code:

SYM	ASM
15°-BA15	35°-BA35
20°-BA20	45°-BA45
30°-BA30	RGB
45°-BA45	30°-BA30

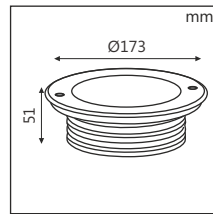
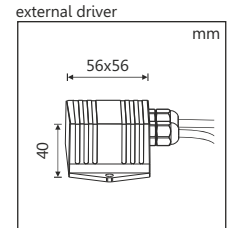

Ref Code	Watt	Volt	mA	Lm(±)
24.27.041.01.12	3x4W(RGBW 4-in-1)	24V DC	583	450

Beam Angle-Code:
RGB

15°-BA15
22°-BA22

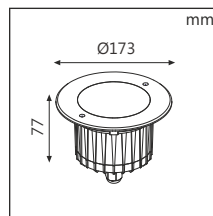
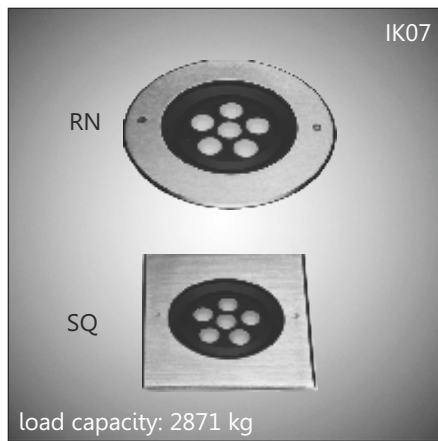
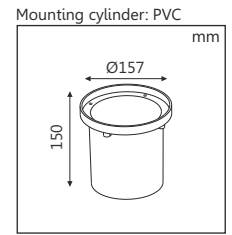

Ref Code	Watt	Volt	mA	Lm(±)
24.27.042.01.12	6x2W(Single Color)	24V DC2	56	800
24.27.042.02.12	6x2W(Single Color)	240V AC	56	
24.27.042.03.12	6x2W(RGB 3-in-1)	24V DC/R/G/B	200/250/250	

Lens-Code:
symmetric-SYM
asymmetric-ASM

Beam Angle-Code:

SYM	ASM
15°-BA15	35°-BA35
20°-BA20	45°-BA45
30°-BA30	RGB
45°-BA45	30°-BA30

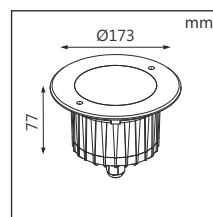
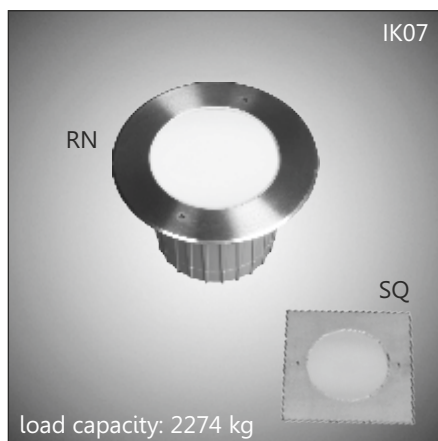
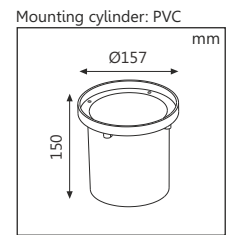

Ref Code	Watt	Volt	mA	Lm(±)
24.27.043.01.3.2	3.2W	24V DC	131	50
24.27.043.02.4.5	4.5W	240V AC	38	
24.27.043.03.3.5	3.5W (RGB 3-in-1)	24V DC(R/G/B)	38/53/54	

Beam Angle: >120°

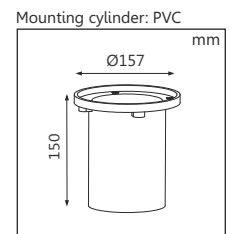



buried up-lights

Mounting: buried in ground/wall
Housing: die-cast powder coated aluminum
Trim: Stainless steel 1.4401 (SUS316)
Reflector: faceted aluminum
Diffuser: 10 mm step tempered glass
Gasket: molding shaped seal

LED: COB (Nichia/Osram)
CRI: Ra>80
CCT: CT27-2700K/CT30-3000K
 CT40-4000K/CT50-5000K
 CT60-6000K
 RGB/RGBW/Amber
Note: * Other CRI/CCT available on request

LED driver: integral/remote
Volt AC: 100-240V
Volt DC: 24V
Frequency: 50/60Hz
LED driver options:
 ND - non-dimmable
 PH - phase dimmable
 010V - 0-10V dimmable
 DALI - compatible

Application:
 outdoors
 floors/decks/pathways
 landscapes
 building facades
Ambient Temp: -35°~+55°C

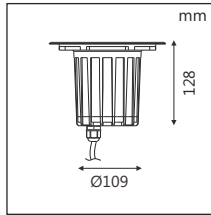
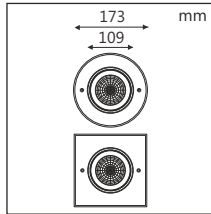
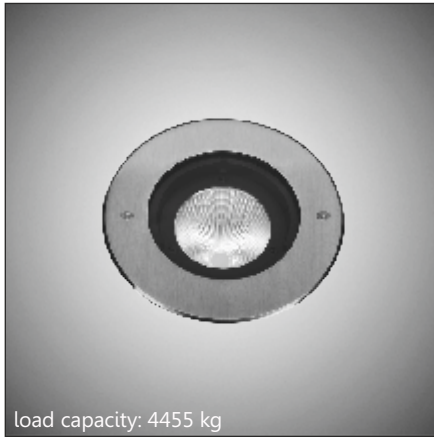

Ref Code	Watt	Volt	mA	Lm(±)
24.27.044.01.13.7	13.7W	24V DC	529	1250
24.27.044.02.13.7	13.7W	240V AC	64	

Beam Angle-Code:
 12°-BA12
 22°-BA22
 35°-BA35
 55°-BA55

Power Cable:
 (DC 24V) 2x1.0mm²/L=2.0m
 (AC 220V) 3x1.0mm²/L=2.0m
 (RGB) 4x0.75mm²/L=0.5m
 (RGBW) 5x0.5mm²/L=0.5m

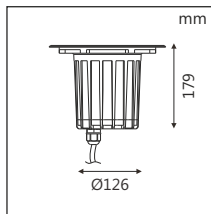
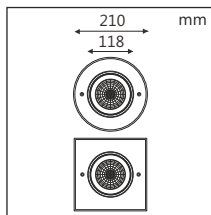
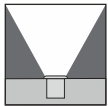
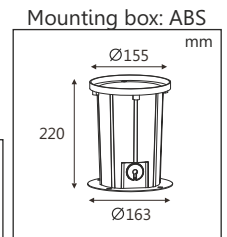
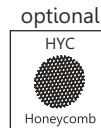

Ref Code	Watt	Volt	mA	Lm(±)
24.27.045.01.18	18W	24V DC	700	1600
24.27.045.02.18	18W	240V AC	85	

Beam Angle-Code:
 10°-BA10
 22°-BA22
 38°-BA38

Power Cable:
 (DC 24V) 2x1.0mm²/L=2.0m
 (AC 220V) 3x1.0mm²/L=2.0m
 (RGB) 4x0.75mm²/L=0.5m
 (RGBW) 5x0.5mm²/L=0.5m

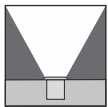
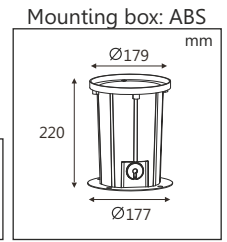
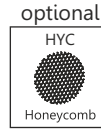

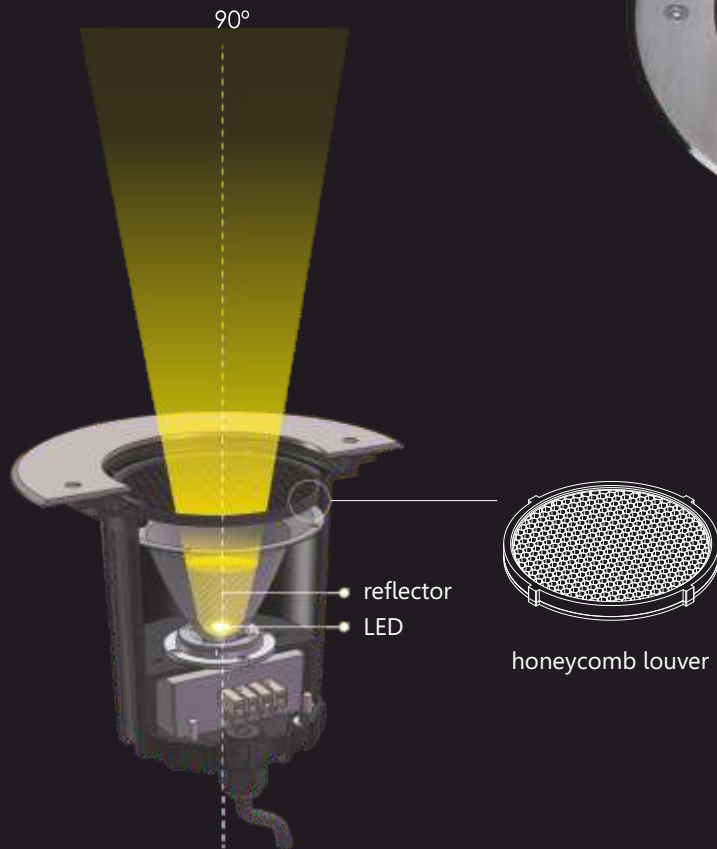
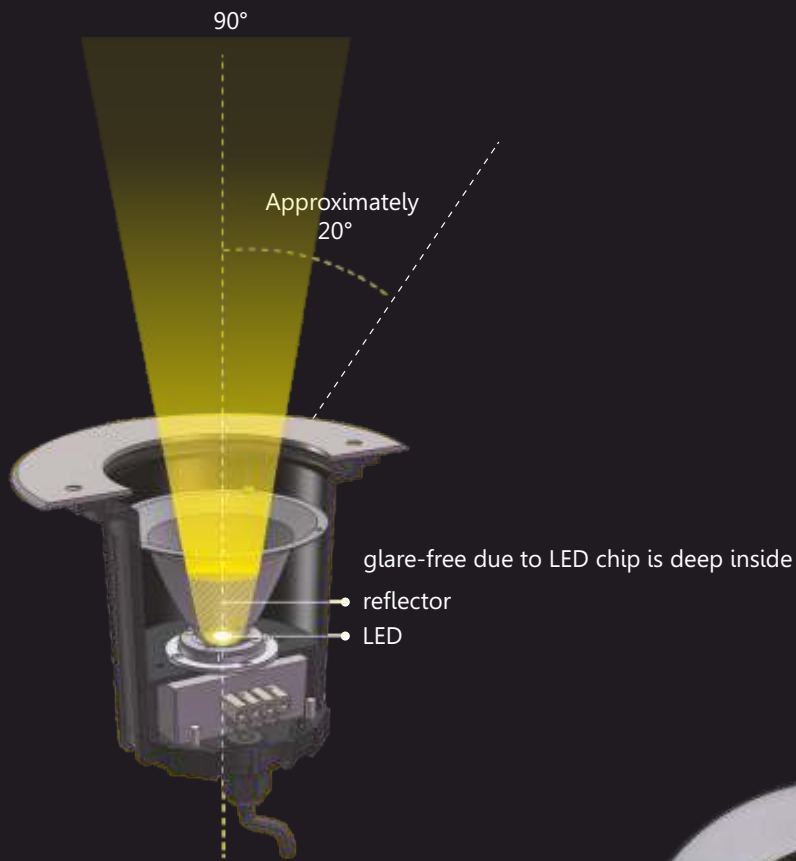

buried up-lights

Mounting: buried in ground
Housing: high pressure die-cast aluminum
Trim: stainless steel 1.4401 (SUS316)
Trim options:
 -round (RN)
 -square (SQ)
Diffuser: 12mm tempered glass
Note:
 * Other CRI/CCT available on request

LED: SMD/COB (Cree)
CRI:
 Ra>80 (±3000K)
 Ra>75 (±4000K)
CCT:
 CT28-2800K/CT32-3250K
 CT40-4000K/CT45-4500K
 RGB
Lumen range:
 75 lm/w (±3000K)

LED driver: integral/remote
Frequency: 50/60Hz
LED driver options:
 ND - non-dimmable
 PH - phase dimmable
 010V - 0-10V dimmable
 DALI - compatible
 DMX512 - compatible

Application:
 outdoors, landscapes
 roads/pathways
 building facades, columns
Ambient Temp: -25°~+55°C
Ambient humidity: 10%~50%

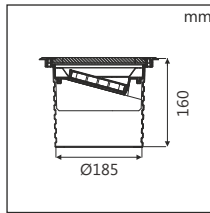
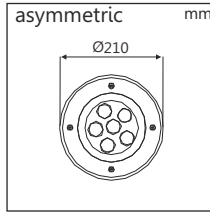

Ref Code	Watt	Volt	LED	LED Color	Beam
24.26.046.01.14	14W	DC24V	SMD(x6)	RGB	asymmetric
24.26.046.02.16	16W	AC240V	SMD(x7)	WH	asymmetric
24.26.046.03.16	16W	DC24V	SMD(x7)	WH	asymmetric

Beam Angle Code:

- 5°-BA05
- 12°-BA12
- 20°-BA20
- 30°-BA30
- 45°-BA45
- 60°-BA60
- 15°x30°-BA15x30
- 10°x60°-BA10x60



Notes:
 * RGB-DC 24V-DMX512
 * lm output mentioned is based on delivered lm output data
Ordering Guide:
 24.26.046.01.14+SQ+CT30+BA20+ND
 (item+trim option+CCT+beam angle+driver)

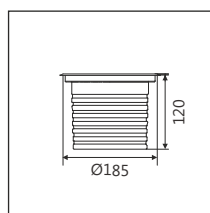
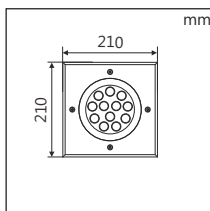
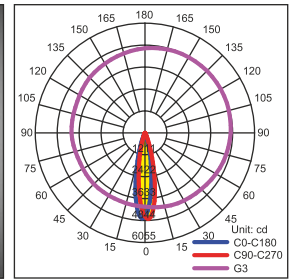
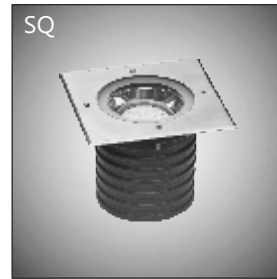

Ref Code	Watt	Volt	LED	LED Color	Beam
24.26.047.01.14	14W	AC240V	SMD(x12)	WH	symmetric
24.26.047.05.14	14W	DC24V	SMD(x12)	WH	symmetric
24.26.047.03.14	14W	DC24V	SMD(x12)	RGB	symmetric
24.26.047.02.22	22W	AC240V	SMD(x12)	WH	symmetric
24.26.047.06.22	22W	DC24V	SMD(x12)	WH	symmetric
24.26.047.04.22	22W	DC24V	SMD(x12)	RGB	symmetric

Beam Angle Code:

- 5°-BA05°
- 12.5°-BA12.5
- 20°-BA20
- 30°-BA30
- 45°-BA45

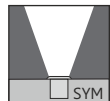

Notes:
 * RGB-DC 24V-DMX512
 * lm output mentioned is based on delivered lm output data
Ordering Guide:
 24.26.048.01.14+SQ+CT30+BA20+ND
 (item+square+CCT+beam angle+driver)

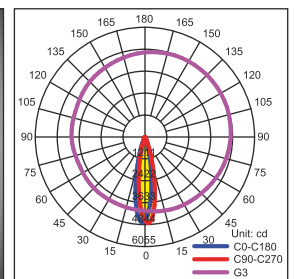

Mounting: buried in ground
Housing: high pressure die-cast aluminum
Trim: stainless steel 1.4401 (SUS316)
Trim options:
 -round (RN)
 -square (SQ)
Diffuser: 12mm tempered glass
Note:
 * Other CRI/CCT available on request

LED: SMD (Cree)
CRI:
 Ra>80 (±3000K)
 Ra>75 (±4000K)
CCT:
 CT28-2800K/CT32-3250K
 CT40-4000K/CT45-4500K
 RGB
Lumen range:
 75 lm/w (±3000K)

LED driver: integral/remote
Frequency: 50/60Hz
LED driver options:
 ND - non-dimmable
 PH - phase dimmable
 010V - 0-10V dimmable
 DALI - compatible
 DMX512 - compatible

Application:
 outdoors, landscapes
 roads/pathways
 building facades, columns
Ambient Temp: -25°~+55°C
Ambient humidity: 10%~50%

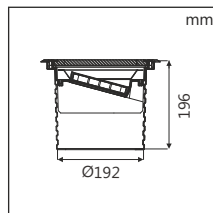
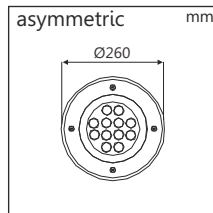

Ref Code	Watt	Volt	LED	LED Color	Beam
24.26.048.01.14	14W	AC240V	SMD(x12)	WH	asymmetric
24.26.048.05.14	14W	DC12-24V	SMD(x12)	WH	asymmetric
24.26.048.03.14	14W	DC12-24V	SMD(x12)	RGB	asymmetric
24.26.048.02.32	32W	AC240V	SMD(x12)	WH	asymmetric
24.26.048.06.32	32W	DC12-24V	SMD(x12)	WH	asymmetric
24.26.048.04.32	32W	DC12-24V	SMD(x12)	RGB	asymmetric

Beam Angle Code:
 5°-BA05
 12°-BA12
 20°-BA20
 30°-BA30
 45°-BA45
 60°-BA60
 15°x30°-BA15x30
 10°x60°-BA10x60

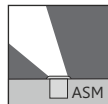

Notes:
 * RGB-DC 24V-DMX512
 * lm output mentioned is based on delivered lm output data
Ordering Guide:
 24.26.048.01.14+SQ+CT30+BA20+ND
 (item+square+CCT+beam angle+driver)

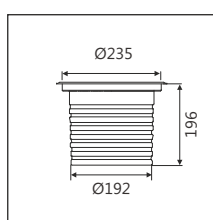
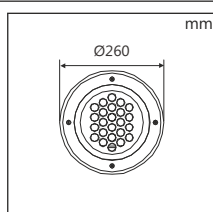

Ref Code	Watt	Volt	LED	LED Color	Beam
24.26.049.01.21	21W	AC240V	SMD(x18)	WH	symmetric
24.26.049.09.21	21W	DC12-24V	SMD(x18)	WH	symmetric
24.26.049.05.21	21W	DC12-24V	SMD(x18)	RGB	symmetric
24.26.049.02.30	30W	AC240V	SMD(x18)	WH	symmetric
24.26.049.10.30	30W	DC12-24V	SMD(x18)	WH	symmetric
24.26.049.06.30	30W	DC12-24V	SMD(x18)	RGB	symmetric
24.26.049.03.30	30W	AC240V	SMD(x24)	WH	symmetric
24.26.049.11.30	30W	DC12-24V	SMD(x24)	WH	symmetric
24.26.049.07.30	30W	DC12-24V	SMD(x24)	RGB	symmetric
24.26.049.04.40	40W	AC240V	SMD(x24)	WH	symmetric
24.26.049.12.40	40W	DC12-24V	SMD(x24)	WH	symmetric
24.26.049.08.40	40W	DC12-24V	SMD(x24)	RGB	symmetric

Beam Angle-Code:
 5°-BA05
 12°-BA12
 20°-BA20
 30°-BA30
 48°-BA48

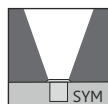

Notes:
 * RGB-DC 24V-DMX512
 * lm output mentioned is based on delivered lm output data
Ordering Guide:
 24.26.049.01.21+SQ+CT30+BA20+ND
 (item+square+CCT+beam angle+driver)

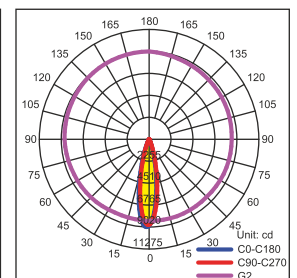

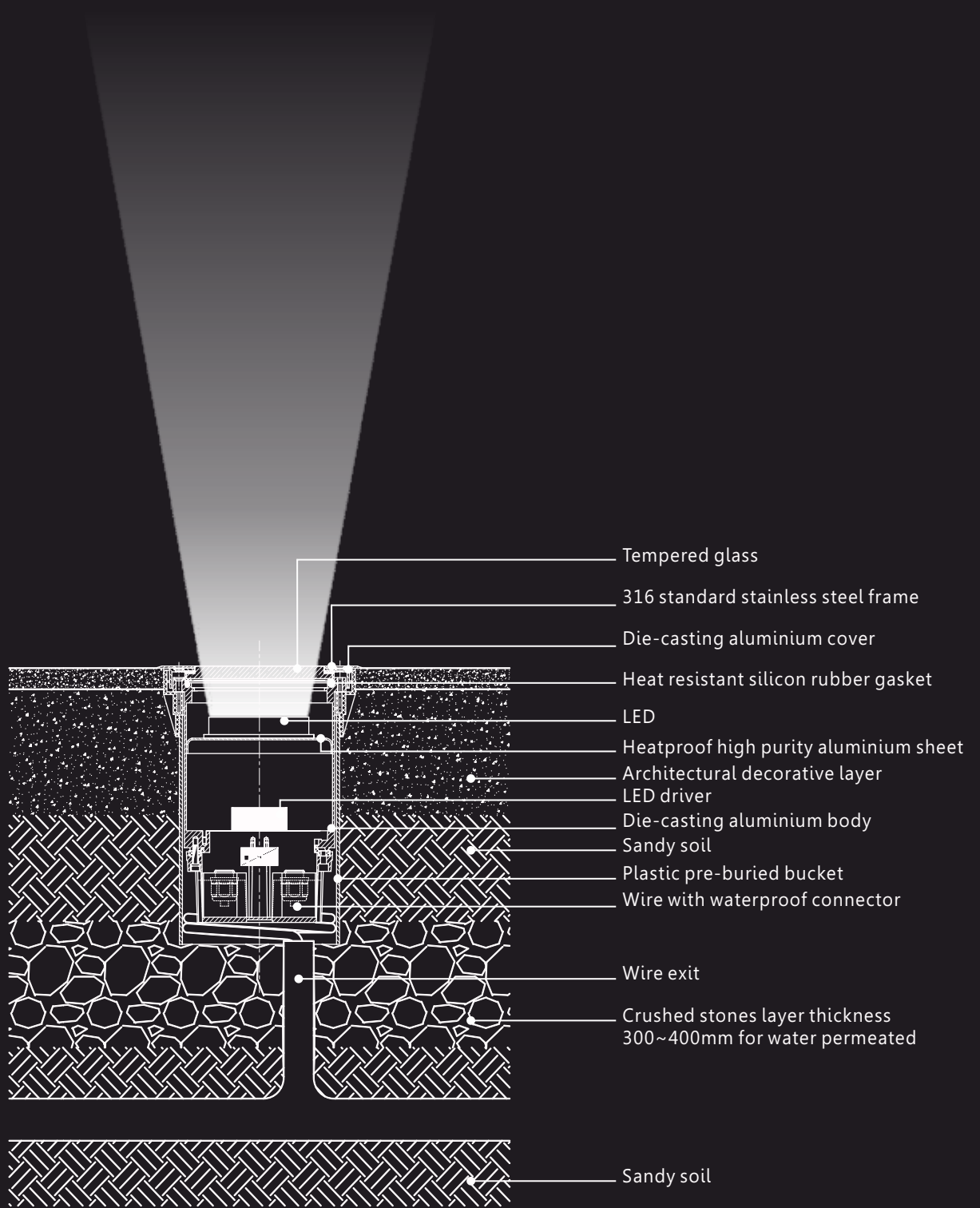

Mounting: buried in ground

Housing:

die-cast powder coated aluminum

Trim: hard chrome-plated stainless steel 1.4401 (SUS316)

Diffuser: step tempered glass

Gasket: molding shaped silicone seal

Note:

* Other CRI/CCT available on request

LED: Cree

CRI: Ra > 70

CCT:

CT30-3000K

CT50-5000K

RGBW

Note: * Lm given in data is based on 4000K

LED driver:

Constant Voltage Input

Constant Current Output

Volt AC: 240V

Volt DC: 24V

Frequency: 50/60Hz

LED driver options:

ND - non-dimmable

PH - phase dimmable

010V - 0-10V dimmable

DALI - compatible

Application:

outdoors

floors/decks/pathways

landscapes

building facades

columns

Ambient Temp: -35° ~ +55°C



load capacity: 5356 kg

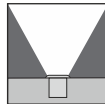
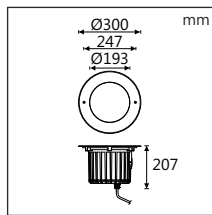

Ref Code	Watt	Volt	mA	Lm(±)
24.27.069.01.45	45W (COB)	240V AC	187	3500

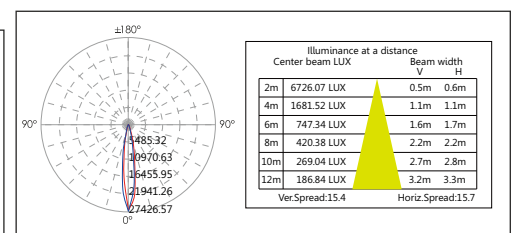
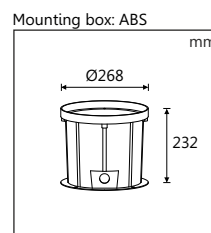

Beam Angle-Code:

15°-BA15

25°-BA25

36°-BA36



load capacity: 5016 kg

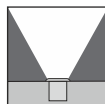
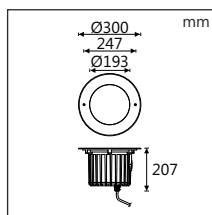

Ref Code	Watt	Volt	mA	Lm(±)
24.27.070.01.45	45W (COB)	240V AC	187	4400

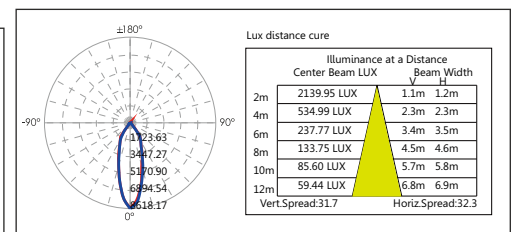
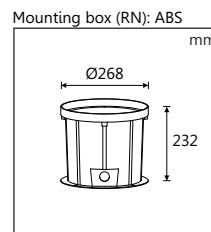

Beam Angle-Code:

8°-BA08

24°-BA24

38°-BA38

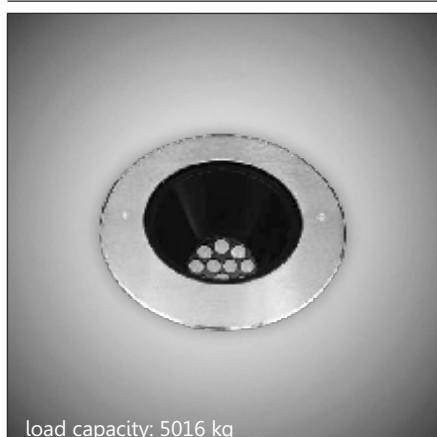
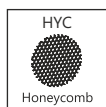

load capacity: 5016 kg

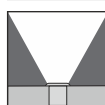
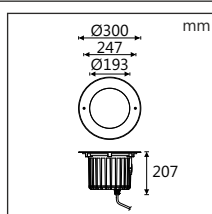

Ref Code	Watt	Volt	mA	Lm(±)
24.27.071.01.43	43W	24V DC	1802	3100
24.27.071.02.60	60W (RGBW)	24V DC	2500	2100

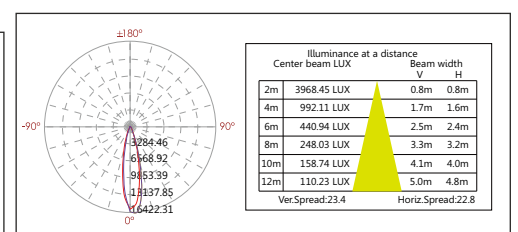
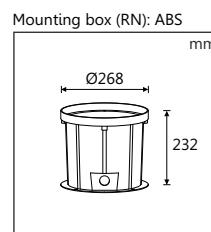

Beam Angle-Code:

9°-BA09

15°-BA15

20°-BA20

30°-BA30

45°-BA45

60°-BA60

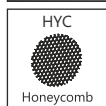

buried up-lights

Mounting: buried in ground
Housing: die-cast powder coated aluminum
Trim: hard chrome-plated stainless steel 1.4401 (SUS316)
Diffuser: step tempered glass
Gasket: molding shaped silicone seal
Note:
 * Other CRI/CCT available on request

LED: Cree/ Nichia
CRI: Ra > 70
CCT:
 CT30-3000K
 CT50-5000K
 RGBW
Note: * Lm given in data is based on 4000K

LED driver:
 Constant Voltage Input
 Constant Current Output
Volt AC: 240V
Volt DC: 24V
Frequency: 50/60Hz
LED driver options:
 ND - non-dimmable
 PH - phase dimmable
 010V - 0-10V dimmable
 DALI - compatible

Application:
 outdoors
 floors/decks/pathways
 landscapes
 building facades
 columns
Ambient Temp: -35° ~ +55°C



load capacity: 5356 kg

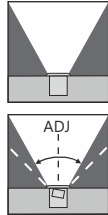
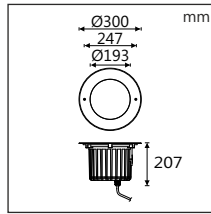

Ref Code	Watt	Volt	mA	Lm(±)
24.27.066.01.25	25W (COB)	24V DC	1040	2700
24.27.066.02.28	28W (COB)	240V AC	130	

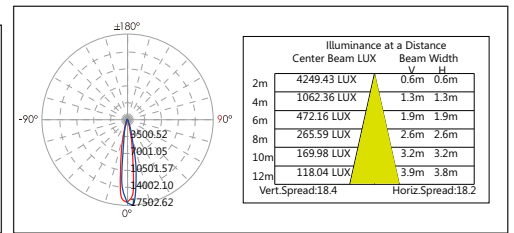
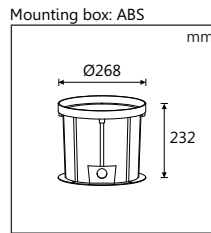

Beam Angle-Code:
 15°-BA15
 25°-BA25
 36°-BA36



load capacity: 5356 kg

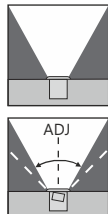
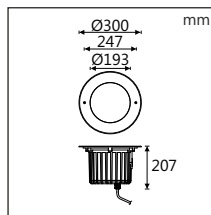

Ref Code	Watt	Volt	mA	Lm(±)
24.27.067.01.28	28W	24V DC	1150	2400
24.27.067.02.28	28W	240V AC	125	

Beam Angle: 20°

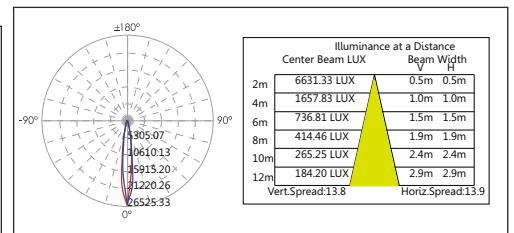
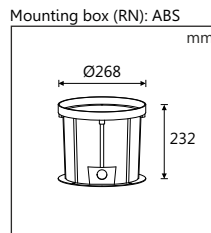

Beam Angle-Code:
 12°-BA12
 20°-BA20
 28°-BA28
 35°-BA35



load capacity: 5356 kg

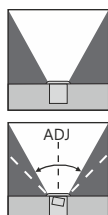
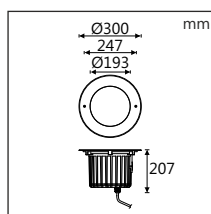

Ref Code	Watt	Volt	mA	Lm(±)
24.27.068.01.48	12x4W (RGBW)	24V DC	2000	1880

Beam Angle: 30°

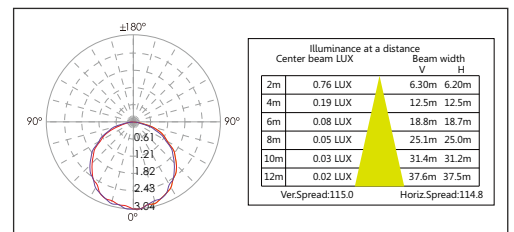

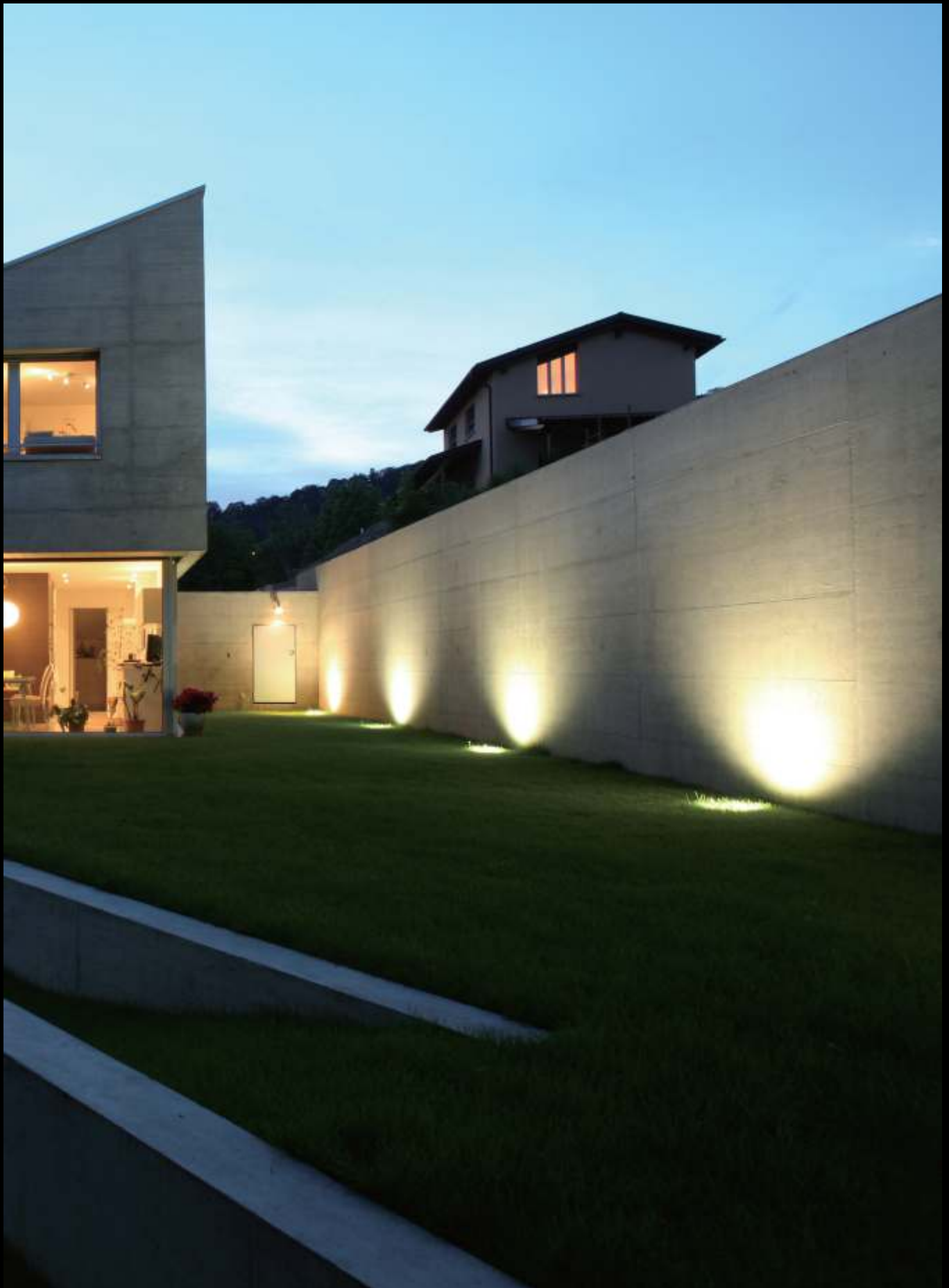

Mounting:
buried in ground
Front cover:
- stainless steel 1.4401 (SUS316)
Diffuser:
- polycarbonate
- tempered glass
Gasket:
silicone

LED: CREE
CRI: Ra>80
 CCT:
CT40-4000K
CT50-5000K
CT60-6000K
RGB/Amber
Note: *Other CRI/CCT
available on request

LED driver:
integral/ external
Volt DC:
12V/24V
Frequency:
50/60Hz
Power cable:
Single Color: 2x1.0mm²/L=3.0m
RGB: 4x0.75mm²/L=3.0m

Application:
outdoors
pathways/driveways
parking areas
Ambient Temp:
-35°~+55°C

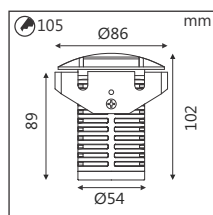

Ref Code	Watt	Volt	Lm(±)
25.25.001.01.07	7W	24V DC	25/50/45/45
25.25.001.02.07	7W	220-240V AC	25/50/45/45

LED white CCT range: 2700-6500K

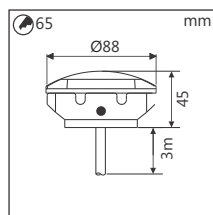
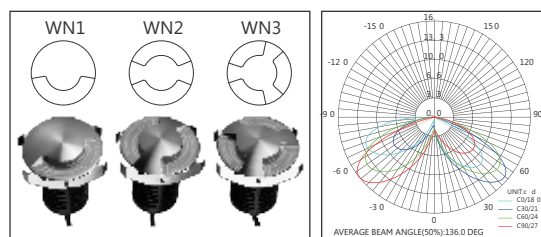
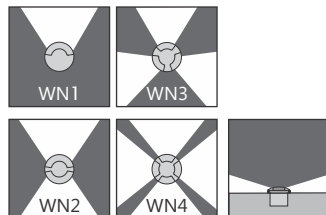

Ref Code	Watt	Volt
25.31.002.01.03	3W (WH, CREE)	CC, 350mA
25.31.002.02.03	3W (WH, CREE)	CV, 12/24V DC

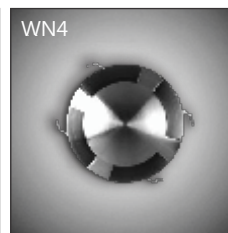
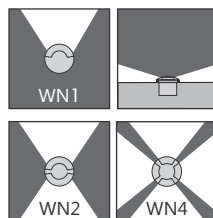

Note:
fixed single colors available:
red, green, blue, amber

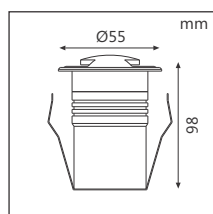
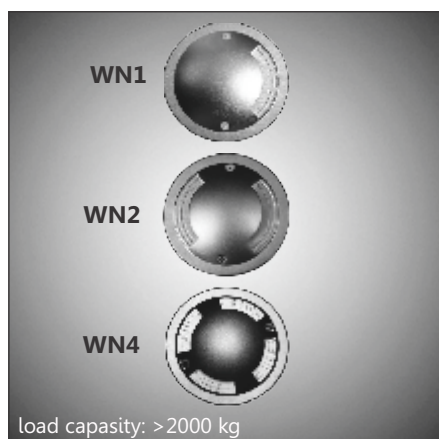

Ref Code	Watt	Volt	mA
25.27.004.01.02	2W	24V DC	110
25.27.004.02.02	2W	240V AC	28

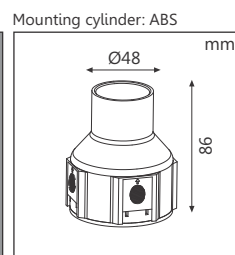
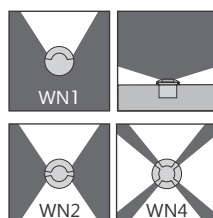

Mounting:
buried in ground
Housing:
die-casting powder coated aluminum
Front cover:
hard chrome-plated stainless steel 1.4401 (SUS316)
Diffuser:
tempered glass

LED: SMD 5630
CRI: Ra>80
CCT:
CT40-4000k
CT50-5000k
CT60-6000k
Note: *Other CRI/CCT available on request

LED driver:
integral/ external
Volt AC: 240V
Volt DC: 24V
Frequency: 50/60Hz
Power Cable:
(AC240V) 3x1.0mm²/L=0.5m
(DC24V) 2x1.0mm²/L=0.5m

Application:
outdoors
pathways/driveways
parking areas
Ambient Temp: -35°~+55°C

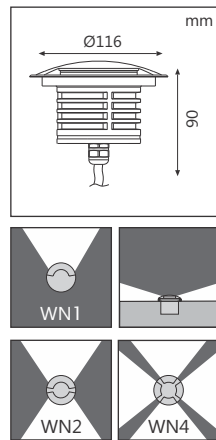
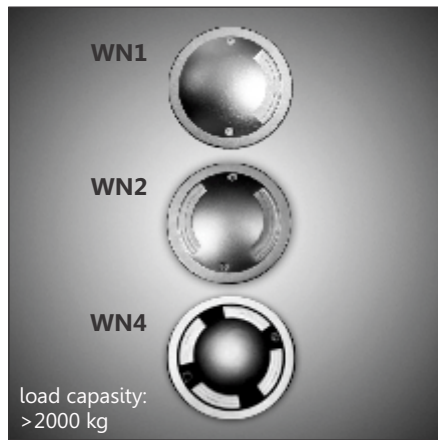

Ref Code	Watt	Volt	mA
25.27.005.01.03	6x0.5W	24V DC	126
25.27.005.02.03	6x0.5W	240V AC	33

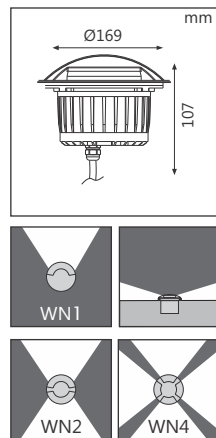
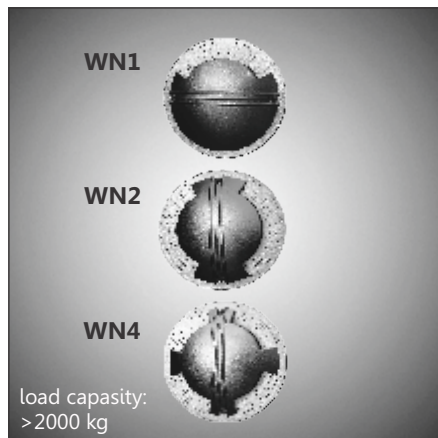
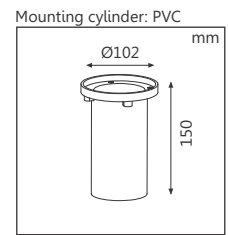

Ref Code	Watt	Volt	mA
25.27.006.01.0.8(x1)	0.8W	24V DC	34
25.27.006.02.1.4(x1)	1.4W	240V AC	17
25.27.006.03.1.6(x2)	1.6W	24V DC	68
25.27.006.04.2.9(x2)	2.9W	240V AC	27
25.27.006.05.1.7(x4)	1.7W	24V DC	71
25.27.006.06.03(x4)	3W	240V AC	28

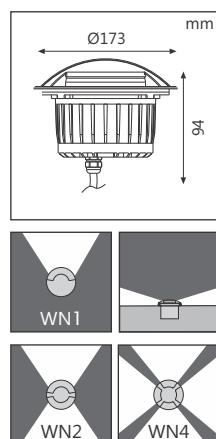
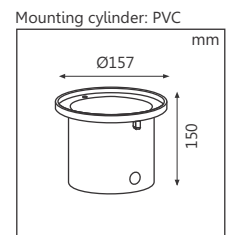

Ref Code	Watt	Volt	mA
25.27.007.01.03	6x0.5W	24V DC	126
25.27.007.02.03	6x0.5W	240V AC	33

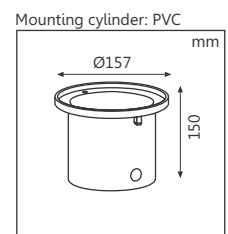



Mounting:
buried in ground
Housing/top:
die-cast aluminum
Diffuser:
stainless steel 1.4401 (SUS316)
Finish options:
* RAL colors available on request

LED: CREE
CRI: Ra > 80
CCT:
CT40-4000k
CT50-5000k
CT60-6000k
Note: *Other CRI/CCT available on request

LED driver: integral
Volt AC: 100-240V
Volt DC: 24V
Frequency: 50/60Hz
Note: *Lm given in data is based on 3000k

Application:
outdoors
pathways/driveways
parking areas
Ambient Temp: -35°~+55°C

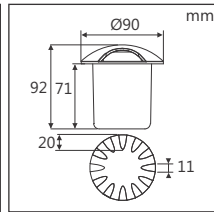

Ref Code	Watt	LED Qty	LED Color	Lm(±)	Windows
25.26.008.01.03	3W	1Pcs	Single	225	1Window
25.26.008.02.04	4W	2Pcs	Single	300	2Window
25.26.008.03.08	8W	4Pcs	Single	600	4Window
25.26.008.04.08	8W	4Pcs	Single	600	12Window

Beam Angle-Code:
1x60°-BA1x60
2x60°-BA2x60
4x60°-BA4x60
12x15°-BA12x15

